

RWC5020A LoRa Tester

Operating Manual

Version 1.15 (ENG)
(RWC5020A FW Version 1.15)

December 2018



Contents

I. General Information	5
1.1 Warranty.....	6
1.2 Safety Considerations	7
1.2.1 Injury Precautions	7
1.2.2 Product Damage Precautions	7
1.2.3 Safety Symbols and Terms.....	8
1.3 Contact Information.....	9
1.4 Key Features	10
1.5 Specifications.....	12
1.6 Initial Inspection	13
1.7 Power Requirement.....	13
1.8 Operating Environment.....	14
II. Basic Operation.....	15
2.1 Front Panel View.....	16
2.2 Rear Panel View.....	18
2.3 Common Operation.....	19
2.3.1 Main Menu Selection	19
2.3.2 Sub Menu Selection	19
2.3.3 Parameter Setup	20
2.3.4 System Setup.....	20
2.3.5 Rotary Knob.....	21
2.3.6 Data Input and Modification	21
2.3.7 Edit String	21
2.4 Menu Structure	22
2.5 Display Screen	23
2.5.1 Title Bar	23
2.5.2 Parameter Configuration Screen	23
2.5.3 System Configuration Screen.....	24
2.5.4 Link Analyzer Screen.....	24
2.5.5 Power vs. Time Screen.....	25
2.5.6 Power vs. Channel Screen.....	26
2.5.7 Receiver Sensitivity Screen	26
2.6 Ethernet IP Setup	27
2.7 Firmware Upgrade	28
2.8 Save/Recall	31
2.8.1 Save Method	31
2.8.2 Recall Method.....	31
2.8.3 Selection of Boot Configuration	32
III. Functional Operation	33
3.1 Parameter Configuration and Basic Setup for EDT.....	34

3.1.1 Overview.....	34
3.1.2 PROTOCOL Parameters.....	35
3.1.3 RF Parameters.....	38
3.2 Activation Procedure for EDT.....	41
3.2.1 Overview.....	41
3.2.2 OTAA Procedure.....	41
3.2.3 ABP Procedure.....	44
3.3 Usage of Link Analyzer for EDT.....	47
3.3.1 Overview.....	47
3.3.2 Test Procedure.....	47
3.3.3 Parameters.....	48
3.4 Usage of Power vs. Time for EDT.....	56
3.4.1 Overview.....	56
3.4.2 Test Procedure.....	56
3.4.3 Parameters.....	57
3.5 Usage of Power vs. Channel for EDT.....	58
3.5.1 Overview.....	58
3.5.2 Test Procedure.....	58
3.5.3 Parameters.....	58
3.6 Usage of Receiver Sensitivity for EDT.....	60
3.6.1 Overview.....	60
3.6.2 Test Procedure.....	60
3.6.3 Parameters.....	61
3.7 Transmission of MAC Commands for EDT.....	63
3.7.1 Overview.....	63
3.7.2 Test Procedure.....	63
3.8 Usage of Link Analyzer for Class B EDT.....	65
3.8.1 Overview.....	65
3.8.2 Test Procedure.....	65
3.9 Parameter Configuration and Basic Setup for GWT.....	67
3.9.1 Overview.....	67
3.9.2 PROTOCOL Parameters.....	68
3.9.3 RF Parameters.....	71
3.10 Activation Procedure for GWT.....	73
3.10.1 Overview.....	73
3.10.2 OTAA Procedure.....	73
3.10.3 ABP Procedure.....	75
3.11 Usage of Link Analyzer for GWT.....	77
3.11.1 Overview.....	77
3.11.2 Test Procedure.....	77
3.11.3 Parameters.....	78
3.12 Usage of Power vs. Time for GWT.....	80
3.12.1 Overview.....	80
3.12.2 Test Procedure.....	80

3.12.3 Parameters.....	81
3.13 Usage of Power vs. Channel for GWT	82
3.13.1 Overview.....	82
3.13.2 Test Procedure.....	82
3.13.3 Parameters.....	82
3.14 Usage of Receiver Sensitivity for GWT	84
3.14.1 Overview.....	84
3.14.2 Test Procedure.....	84
3.14.3 Parameters.....	85
3.15 Transmission of MAC Commands for GWT	86
3.15.1 Overview.....	86
3.15.2 Test Procedure.....	86
3.16 Usage of Link Analyzer for Class B GWT	88
3.16.1 Overview.....	88
3.16.2 Test Procedure.....	88
3.17 Usage of Signal Generator for NST.....	90
3.17.1 Overview.....	90
3.17.2 Test Procedure.....	90
3.17.3 NST_TX Parameters.....	90
3.17.4 PROTOCOL Parameters.....	92
3.17.5 RF Parameters.....	93
3.18 Usage of Signal Analyzer for NST	97
3.18.1 Overview.....	97
3.18.2 Test Procedure.....	97
3.18.3 NST_RX Parameters.....	97
3.18.4 PROTOCOL Parameters.....	98
3.18.5 RF Parameters.....	99
3.19 Usage of MFG for NST	102
3.19.1 Overview.....	102
3.19.2 Test Procedure.....	102
3.19.3 NST_MFG Parameters.....	103
3.19.4 PROTOCOL Parameters.....	105
3.19.5 RF Parameters.....	106
IV. Remote Control Programming.....	109
4.1 Introduction.....	110
4.1.1 Command Structure	110
4.1.2 Command Parameter Types	111
4.1.3 Response to Query	111
4.2 RS-232C Interface	112
4.2.1 Configuration	112
4.2.2 Remote Programming Guide Using RS232C on a Windows System	112
4.3 Ethernet Interface.....	114
4.3.1 Configuration	114
4.4 Command List (for FW V1.12).....	115

4.4.1 Common Commands	115
4.4.2 System Commands.....	115
4.4.3 Commands for RF Parameters	115
4.4.4 Commands for PROTOCOL Parameters	117
4.4.5 Commands for LINK	123
4.4.6 Commands for POW_TIME & POW_CH.....	130
4.4.7 Commands for SENSITIVITY	133
4.4.8 Commands for NST	135
4.4.9 Commands for SYSTEM.....	140
V. Revision History.....	142

I. General Information

This chapter covers specifications, key features, warranty, and safety consideration of the Instrument.

- 1.1 Warranty
- 1.2 Safety Considerations
- 1.3 Contact Information
- 1.4 Key Features
- 1.5 Specifications
- 1.6 Initial Inspection
- 1.7 Power Requirement
- 1.8 Operating Environment

1.1 Warranty

RedwoodComm Warrants that this product will be free from defects in materials and workmanship for a period of two(2) years from the date of shipment. During the warranty period, RedwoodComm Company will, at its option, either repair or replace products that prove to be defective.

For warranty service or repair, Customer must notify RedwoodComm of the defect before the expiration of the warranty period and make suitable arrangements for the performance of service. Customer shall be responsible for packaging and shipping the defective product to the service center designated by RedwoodComm. Customer shall prepay shipping charge to RedwoodComm designated service center and RedwoodComm shall pay shipping charge to return the product to customer. Customer is responsible for all shipping charges including freight, taxes, and any other charge if the product is returned for service to RedwoodComm, if customer is located outside of Korea.

LIMITATION OF WARRANTY

The foregoing warranty shall not apply to defects resulting from improper or inadequate malignance by buyer, buyer-supplied software or interfacing, unauthorized modification or misuse, accident or abnormal conditions of operation.

RedwoodComm responsibility to repair or replace deductive products is the sole and exclusive remedy provided to the customer for breach of this warranty. RedwoodComm will not be liable for any indirect, special, incidental, or consequential damages irrespective of whether RedwoodComm has advance notice of the possibility of such damages

1.2 Safety Considerations

Review the following safety precautions to avoid injury and prevent damage to this product or any product connected to it.

1.2.1 Injury Precautions

Use Proper Power Cord

To avoid fire hazard, use only the power cord specified for this product.

Avoid Electric Overload

To avoid electric shock or fire hazard, do not apply a voltage to a terminal that is specified beyond the range.

Ground the Product

This product is grounded through the grounding conductor of the power cord. In case no ground is available at the power outlet, it is recommended to provide a separate grounding path to the instrument by connecting wire between the instrument ground terminal and an earth ground to avoid electric shock or instrument damage. Before making connections to the input or output terminals of the product, ensure that the product is properly grounded.

Do Not Operate Without Covers

To avoid electric shock or product damage, do not operate this product with protective covers removed.

Do Not Operate in Wet/Damp Conditions

To avoid injury or fire hazard, do not operate this product in wet or damp conditions.

Do not use in a manner not specified by the manufacturer

1.2.2 Product Damage Precautions

Use Proper Power Source

Do not operate this product from a power source that applies more than the voltage specified. Main supply voltage fluctuations do not to exceed $\pm 10\%$ of the nominal voltage.

Provided Proper Ventilation

To prevent product overheating, provide proper ventilation.

Do Not Operate With Suspected Failures

If you there is damage to this product, have it inspected by qualified service personnel.

Environmental Conditions

Refrain from using this equipment in a place subject to much vibration, direct sunlight, outdoor and where the flat is not level. Also, do not use it where the ambient temperature is outside 5 °C to 40 °C, and altitude is more than 2000m. The maximum relative humidity is 80% for temperatures up to 31 °C decreasing linearity to 50% relative humidity at 40 °C. Over voltage Installation Category II for mains supply. Pollution Degree 2.

1.2.3 Safety Symbols and Terms

These terms may appear in this manual

WARNING: Warning statements identify conditions or practices that could result in injury or loss of life.

CAUTION: Caution statements identify conditions or practices that could result in damage to this product or other property.

Symbols on the Product: The following symbols may appear on the product



Close



Open



ATTENTION



**Indicates earth
(ground) terminal**

1.3 Contact Information

The contact information of RedwoodComm Headquarters is as follows:

Telephone: +82-70-7727-7011

Technical Support: support@redwoodcomm.com

Homepage: <http://www.redwoodcomm.com>

1.4 Key Features

General Descriptions

RWC5020A is a compact all-in-one tester, providing a perfect solution for test and measurement of LoRaWAN technology, which is fully suitable for R&D, QC, and Manufacturers. It provides various test functions that can be performed in signaling mode, e.g. including activation procedures, as well as non-signaling mode. Automated PC software will help users test and debug their devices by performing pre-certification tests, as specified by LoRa Alliance.

Key Features

3 Operational Modes

- End Device Test
 - Testing an End Device by operating as a Gateway
- Gateway Test
 - Testing a Gateway by operating as an End Device
- Non-signaling Test
 - Generating LoRa frames or continuous waveform

Protocol Functional Tests

- LoRaWAN™ Compatibility
 - Supporting Class A/B/C for V1.0.2, V1.0.3 and V1.1
 - Supported Regions: EU 868, EU 433, US 915, AU 915, CN 470, KR 920, AS 923, IN 865, RU 864
- Link Analyzer
 - Analysis of Protocol messages and parameters
 - Transmission of any type of MAC commands
- Certification Tests (End Device only)
 - LoRaWAN™ Certification: EU V1.5, US V1.3, AS V1.1, KR V1.2, IN1.0
 - * Supporting up to eight 125kHz CHs and one 500kHz CH simultaneously
 - Operator Certification

RF Performance Tests

- End Device Test
 - Receiver Sensitivity Test w.r.t. DR (DR0 ~ DR7) or Downlink Slot (RX1 and RX2 Window)

- TX Power Measurement w.r.t. DR (DR0 ~ DR7) or RF channel (up to 8 channels)
- Gateway Test
 - Receiver Sensitivity Test w.r.t. DR (DR0 ~ DR7)
 - TX Power Measurement w.r.t. DR (DR0 ~ DR7) or RF channel (up to 8+1 channels)
- Manufacturing Tests
 - RX Test: Receiver Sensitivity Test with known test pattern of LoRa frames
 - TX Test: Power Measurement

PC Software

- LoRaWAN Precertification Tests (EDT)
- RF Performance Tests (EDT, GWT, NST)

1.5 Specifications

Frequency

- Range: 400MHz ~ 510MHz, 862MHz ~ 960MHz
- Resolution: 100Hz
- Accuracy: ± 1 ppm/year @ operating temperature

Output Level

- Range: -10dBm ~ -150dBm
- Resolution: 0.5dB
- Accuracy: ± 1 dB
- Impedance: 50 Ω

Input Level

- Range: +30dBm ~ -50dBm
- Measurement Accuracy: ± 1 dB

VSWR

- Better than 1:1.5

Frequency Reference

- Internal Reference & Stability: 10 MHz, ± 1 ppm/year @ operating temperature
- External Reference: 10MHz (0dBm ~ +20dBm MAX)

Remote Programming Ports

- RJ45 (Ethernet)
- RS-232C

Miscellaneous

- Operating temperature: 5 ~ 40°C
- Line Voltage: 100 to 240 VAC, 50/60Hz
- Dimension: 250(w) x 110(h) x 348(d) mm
- Weight: 5kg

1.6 Initial Inspection

After the delivery of the product, damage to its exterior that may occur during the shipping process should be inspected, then it should be carefully checked that all accessories are included as listed in the following table:

NO.	Item Code	Item	Specifications	Q'ty
1	C5020A-00	RWC5020A LoRa Tester		1
2	5020A00-8001	PC program & Manual		1
3	6000-0001-001	RG58, BNC(M) to BNC(M)	L: 1m	1
4	6016-0001-001	MF405, SMA(M) to SMA(M) Cable	L: 0.5m	1
5	6211-0002-001	SMA(F) to N(M) Adaptor		1
6	6210-0003-001	SMA(F) to RP-SMA(M) Adapter		1
7	6500-0001-001	Linear Antenna		1
8	6112-0001-001	RJ45 Cross LAN Cable	2m	1
9	6115-0001-001	RS-232C, Data Cable	1.8m	1
10	6114-00XX-001	Power Cord		1

WARNING: If any damage to interior or exterior of the product is found, please stop using immediately for safety and contact to the technical support.

1.7 Power Requirement

Items	Specifications
Input Voltage	100 VAC - 240 VAC
Input Current	1.2A
Frequency	50/60 Hz
Power Consumption	< 40 watt

CAUTION: If AC power is beyond the range of operation, the equipment may malfunction or could be permanently damaged. Main supply voltage fluctuations should be not to exceed $\pm 10\%$ of the nominal voltage.

1.8 Operating Environment

Refrain from using this equipment in a place subject to much vibration, direct sunlight, outdoor and where the flat is not level. Also, do not use it where the ambient temperature is outside 5 °C to 40 °C, and altitude is more than 2000m.

The maximum relative humidity is 80% for temperatures up to 31 °C decreasing linearity to 50% relative humidity at 40 °C. Over voltage Installation Category II for main supply. Pollution Degree 2.

The storage temperature range for this equipment is –20 °C to 70 °C. When this equipment is not used for a long period of time, store it in a dry place away from direct sunlight, covered with vinyl or placed in a cardboard box.

II. Basic Operation

This section describes the basic concepts and details of operating RWC5020A LoRa Tester. Understanding the basic concept of your RWC5020A may help you use it effectively.

- 2.1 Front Panel View
- 2.2 Rear Panel View
- 2.3 Common Operation
- 2.4 Menu Structure
- 2.5 Display Screen
- 2.6 Ethernet IP Setup
- 2.7 Firmware Upgrade
- 2.8 Save/Recall

2.1 Front Panel View

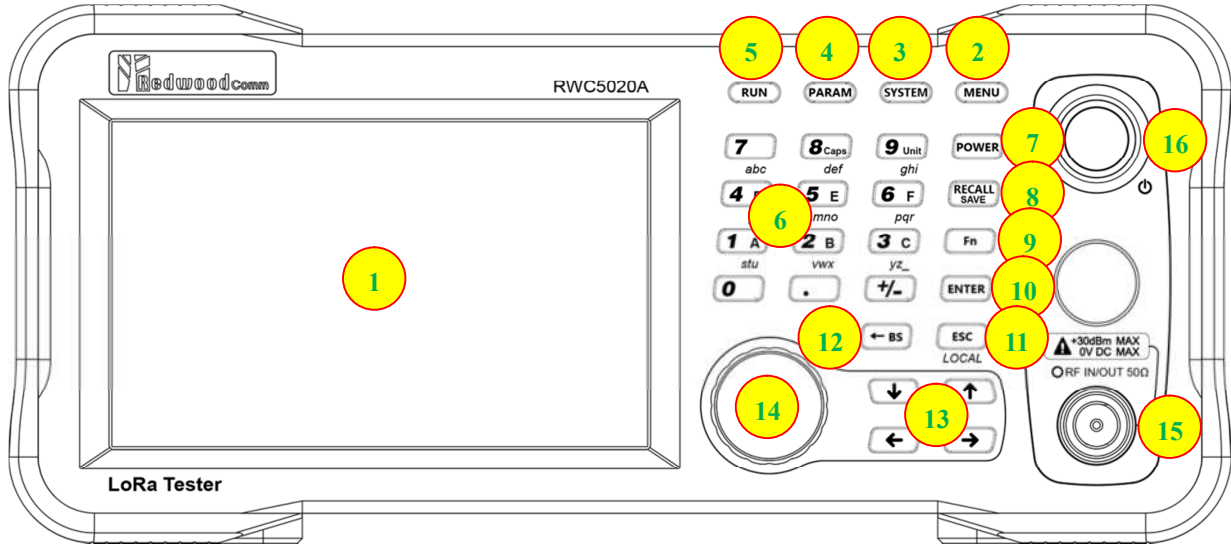















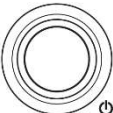

Fig 2.1 RWC5020A Front Panel View

NO	Items	Names and Descriptions
1		5-inch LCD Display
2		Main Menu selection key
3		System Setup key
4		Parameter Setup key
5		RUN / STOP key
6		Number and letter input keys, Float point input key, Minus sign input key

7		Shortcut key for output power setting
8		Shortcut key for recall or save of system and parameter setup
9		Functional key for a secondary key input
10		Data input completion, Input mode switching
11		Input cancel, Popup window release, Return to the previous state, LOCAL mode switching (LOCAL)
12		Key to delete the previous character
13		Cursor move, Tap switching, Cursor mode switching
14		Rotary Knob: Cursor move, value changing Push: same as “ENTER”
15		RF IN/OUT Connectors
16		Power Switch

2.2 Rear Panel View

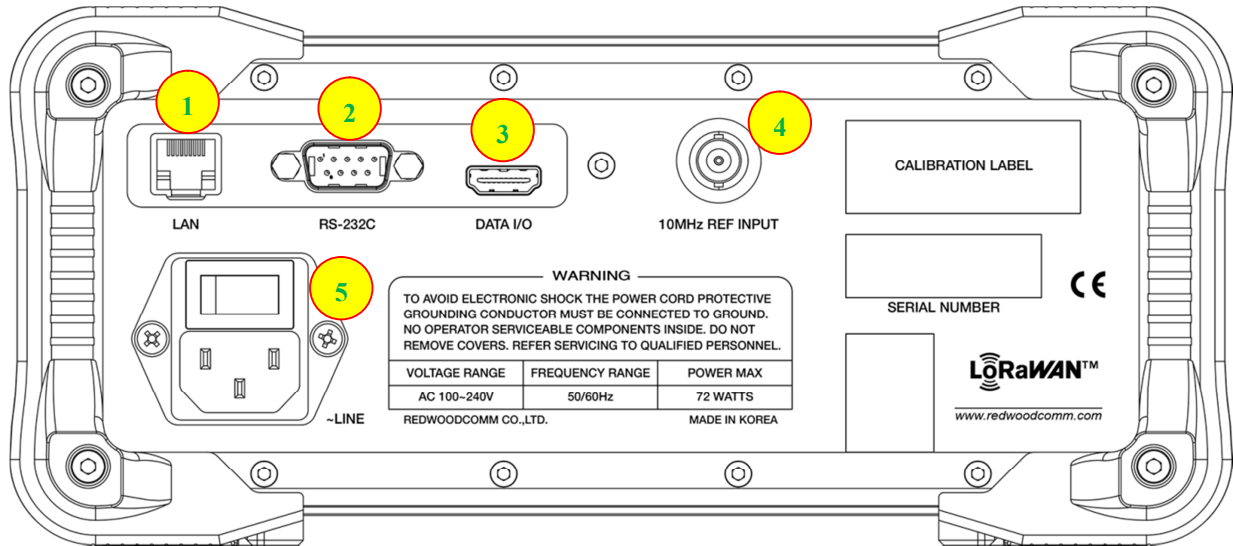



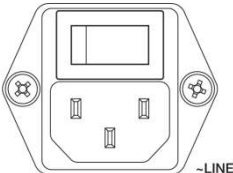

Fig 2.2 RWC5020A Rear Panel View

NO	Items	Names and Descriptions
1	 LAN	Ethernet Interface
2	 RS-232C	RS-232C Interface
3	 DATA I/O	Sync Data I/O between RedwoodComm instruments
4	 10MHz REF INPUT	10MHz External Reference Signal input
5	 -LINE	100~240VAC Power Input

2.3 Common Operation

2.3.1 Main Menu Selection

RWC5020A LoRa Tester has a tree type menu structure and 3 Main Menus. Pressing **MENU** key pops up the Main Menu selection screen and each Main Menu can be selected by pressing a direct number key (1, 2, or 3) or rotating the rotary knob and pressing **ENTER** key. The following figure shows the Main Menu selection screen.

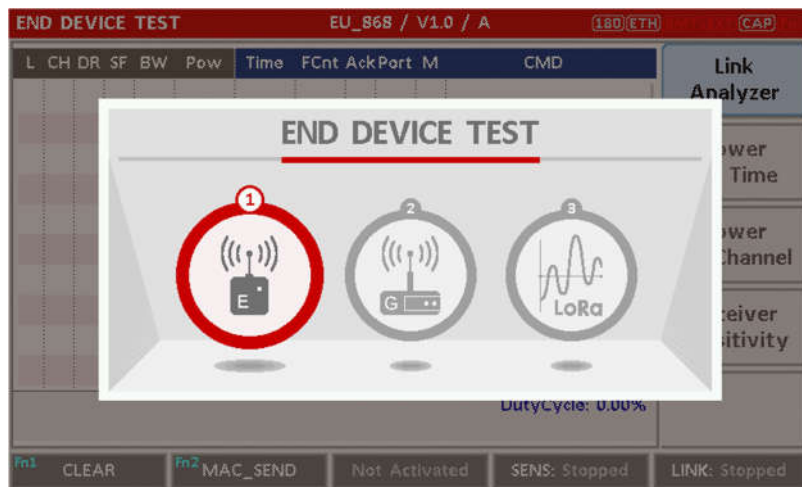

Fig 2.3 Main Menu Selection Screen

Main Menu	Descriptions
END DEVICE TEST	This is a menu for testing End Device; RWC5020A acts as the reference Gateway/ Server to communicate with End Device Under Test, while analyzing protocol messages and measuring the signal quality and performance of DUT.
GATEWAY TEST	This is a menu for testing Gateway; RWC5020A acts as the reference End Device to communicate with Gateway Under Test, while analyzing protocol messages and measuring the signal quality and performance of DUT.
NON-SIGNALING TEST	This is a menu for generating a continuous waveform signal or a LoRa test frame and measuring the power of DUT signal.

2.3.2 Sub Menu Selection

Each main menu has its own Sub Menu as displayed on the right side of the screen. Each Sub Menu can be selected by rotating the rotary knob and pressing **ENTER** key. The following figure shows the example of the Sub Menu selection.

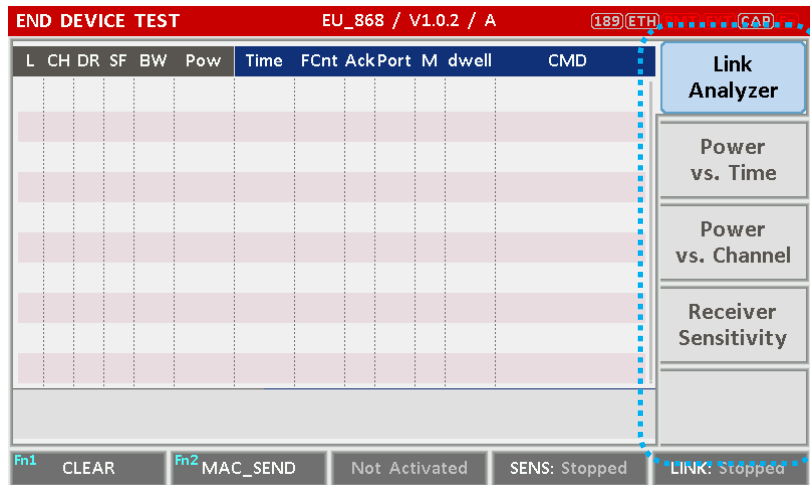

Fig 2.4 Sub-Menu Selection Screen (blue colored box)

2.3.3 Parameter Setup

Pressing **PARAM** key pops up the parameter configuration screen, and it has 3 different taps. The first tap is a parameter set of the current Sub Menu, and the second and the third taps are common sets of protocol and RF parameters respectively. The following figure shows the example of the parameter configuration screen.

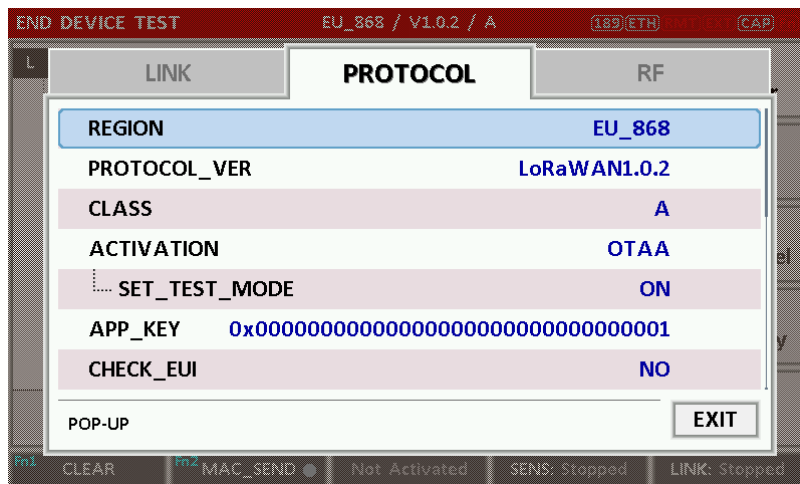

Fig 2.5 Parameter Configuration Screen

2.3.4 System Setup

Pressing **SYSTEM** key pops up the system configuration screen. The **SETUP** tap is a parameter set of the system configuration. The following figure shows the system configuration screen.



Fig 2.6 System Configuration Screen

2.3.5 Rotary Knob

The rotary knob moves the cursor to every field on the screen that can be changed. By positioning the cursor in front of a field and pressing the knob to select that field, you can alter that field's setting.

2.3.6 Data Input and Modification

1. Move the cursor to the desired input field using rotary knob or arrow keys.
2. Push rotary knob or **ENTER** key for data input mode. The cursor indicates data input position. If there are only two alternatives, push the rotary knob or **ENTER** key to toggle the data. In case of pop-up menu rotate the rotary knob to choose.
3. Push Rotary knob to enter data and then the new data is entered.
4. While entering the data, if you press **ESC** or **← BS** key, the input data shall be cancelled or deleted respectively.

2.3.7 Edit String

1. To edit the string, move cursor to the Label parameter and set it to input mode by pushing the rotary knob or **ENTER** key then input cursor will be placed at the last of string. Press the number keys repeatedly, then the numbers and characters are displayed repeatedly.
2. When desired number or character is displayed, please wait until the cursor is moved to next position.

2.4 Menu Structure

RWC5020A has a tree type menu structure as the following figure. There are 3 Main Menus and each Main Menu has 2 ~ 4 Sub Menus.

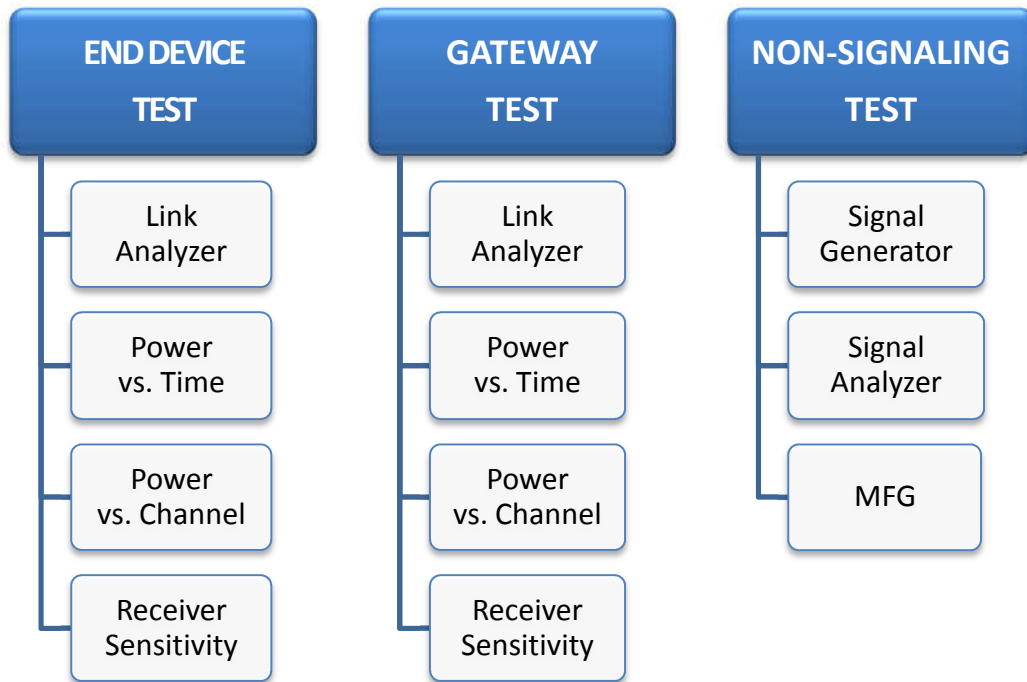

Fig 2.7 RWC5020A Menu Structure

2.5 Display Screen

2.5.1 Title Bar

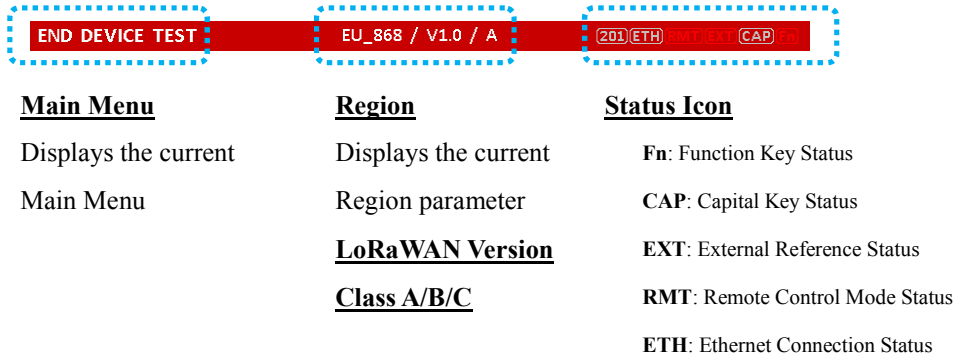

Fig 2.8 Title Bar

2.5.2 Parameter Configuration Screen

Tap

1st Tap: the current screen parameters

2nd Tap: common protocol parameters

3rd Tap: common RF parameters

Cursor

Cursor to select parameter by rotating Rotary knob

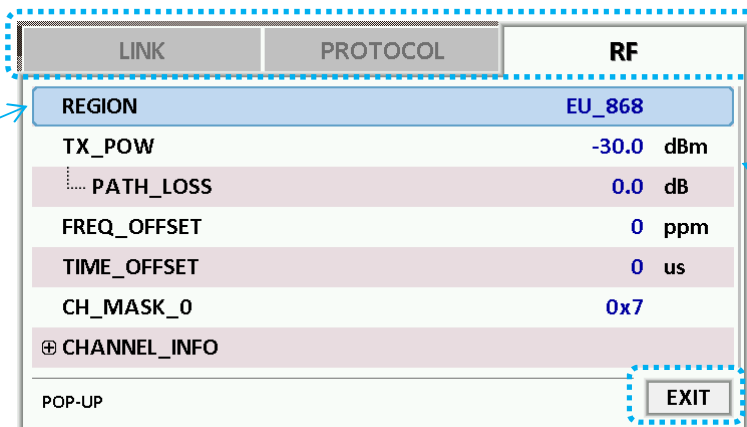

Scroll Bar

When there are a lot of parameters, it indicates the current position

EXIT

Close the screen

Fig 2.9 Parameter Configuration Screen

2.5.3 System Configuration Screen

Tap

1st Tap: the system parameters and information

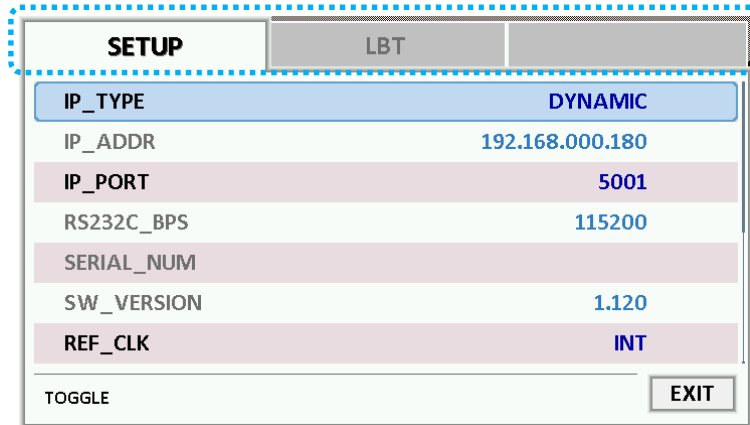

Fig 2.10 System Configuration Screen

2.5.4 Link Analyzer Screen

LINK Message Window

- L: Uplink/Downlink
- CH: Channel Number
- DR: Data Rate
- SF: Spreading Factor
- BW: Bandwidth
- Pow: Measured power
- Time: Time between consecutive frames
- FCnt: FCnt value
- Del: RxDelay value
- Adr: ADR flag
- B: Class B flag
- M: Type (Confirmed/Unconfirmed)
- FP: FPending flag
- AAR: ADRACKReq flag
- CMD: Command Name

Cursor

Cursor to select message by rotating Rotary knob

Contents

Information of Command

Raw Data

Raw data of the current cursor position



Duty Cycle

Calculated duty cycle value of DUT transmission

Fig 2.11 Link Analyzer Screen

CLEAR

Pushing 'CLEAR' or pressing **Fn 1 A** will clear all messages on the Link Analyzer screen and also clear all measured power data in Power vs. Time and Power vs. Channel screens.

MAC SEND

Pushing 'MAC_SEND' or pressing **Fn 2 B** will force RWC5020A to send the selected MAC command to DUT at its next TX period, where the MAC command can be selected in the parameter configuration screen.

LINK

It represents the status of communication link between DUT and RWC5020A; Running or Stopped. Pushing **RUN** key changes the link status in Link Analyzer, Power vs. Time or Power vs. Channel screen.

SENS

It represents the status of the Receiver Sensitivity test of DUT; Running or Stopped. Pushing **RUN** key changes the sensitivity status in Receiver Sensitivity screen.

2.5.5 Power vs. Time Screen

Marker Values

The corresponding values at the current marker position

Marker

marker to select a point by rotating Rotary knob



Measured Power

The measured power values with respect to data rates

Fig 2.12 Power vs. Time Screen

2.5.6 Power vs. Channel Screen

Marker Values

The corresponding values at the current marker position of Power vs Time screen

Power Diagram

The graphical diagram of measured power values

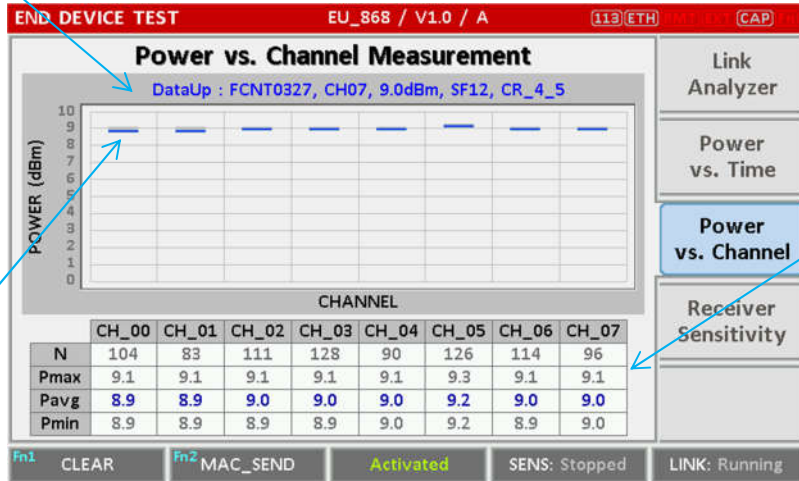

Measured Power

The measured power values with respect to channel

Fig 2.13 Power vs. Channel Screen

2.5.7 Receiver Sensitivity Screen

Test Results

The final test results will be displayed after the completion of the test

Sensitivity Graph

It draws PER graph at each test point

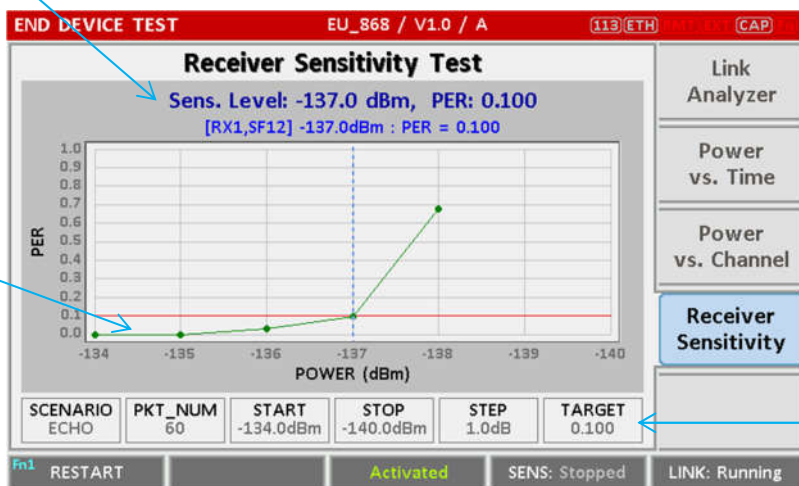

Test Setup

The important test parameters are displayed

Fig 2.14 Receiver Sensitivity Screen

2.6 Ethernet IP Setup

IP configuration can be done by “IP_TYPE” and “IP_ADDR” in the system configuration screen.

“IP_TYPE” parameter can be set to DYNAMIC or STATIC; DYNAMIC means that IP address may be obtained from the DHCP server automatically, and this configuration is recommended for RJ45 connection to a network hub. STATIC means that IP address should be configured manually by users, and this configuration is recommended for direct connection between RWC5020A and a remote PC using a crossover cable.

SETUP	LBT
IP_TYPE	STATIC
IP_ADDR	192.168.000.101
IP_PORT	5001
RS232C_BPS	115200
SERIAL_NUM	
SW_VERSION	1.120
REF_CLK	INT
TOGGLE	EXIT

Fig 2.15 Example of STATIC IP

SETUP	LBT
IP_TYPE	DYNAMIC
IP_ADDR	192.168.000.180
IP_PORT	5001
RS232C_BPS	115200
SERIAL_NUM	
SW_VERSION	1.120
REF_CLK	INT
TOGGLE	EXIT

Fig 2.16 Example of DYNAMIC IP

2.7 Firmware Upgrade

As RWC5020A adapted Flash Memory, it is available to upgrade easily by using a remote PC without changing the hardware. For upgrading, 'RWC_Updater' program shall be used, which is provided together when the product is purchased or available to download the upgrade package including itself and the upgrade binary files from RedwoodComm Website (<http://www.redwoodcomm.com>). The information for upgrading shall be kept in providing to the user via email or website.

Normal Firmware Upgrade Procedure

- 1) Set up Ethernet connection between RWC5020A and a remote PC, using a RJ45 cable for normal connection to network hub or using a crossover cable for direct connection between them.
- 2) In case of direct connection using a crossover cable, IP configuration of a remote PC should be done manually as the following figure. The IP address of a remote PC shall be put with same as that of RWC5020A except the last number.

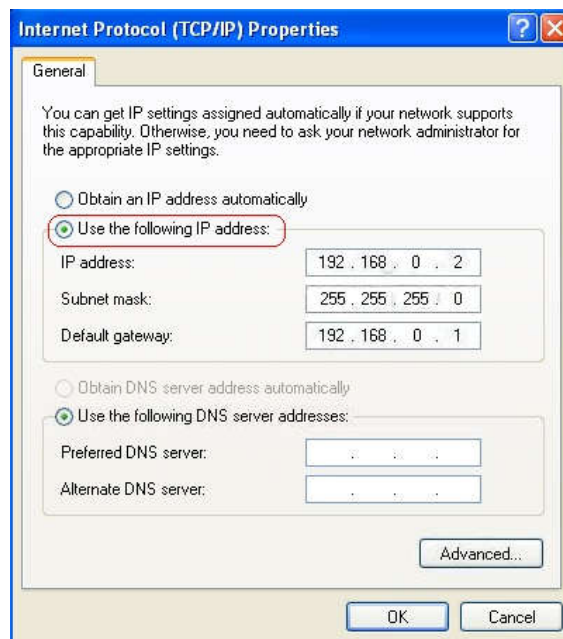

Fig 2.17 IP configuration of a remote PC

CAUTION: For reliable upgrade, it is recommended to disable all other networks (e.g. WiFi, Virtual Machine) than Ethernet network in 'Change Adapter Settings' of a remote PC.

- 3) After downloading upgrade files from RedwoodComm website, execute an application program for upgrading.
- 4) Set up IP address in the application program, and follow the instructions of the program.
- 5) During upgrading, RWC5020A may show the progressing information on its screen as the following figure.

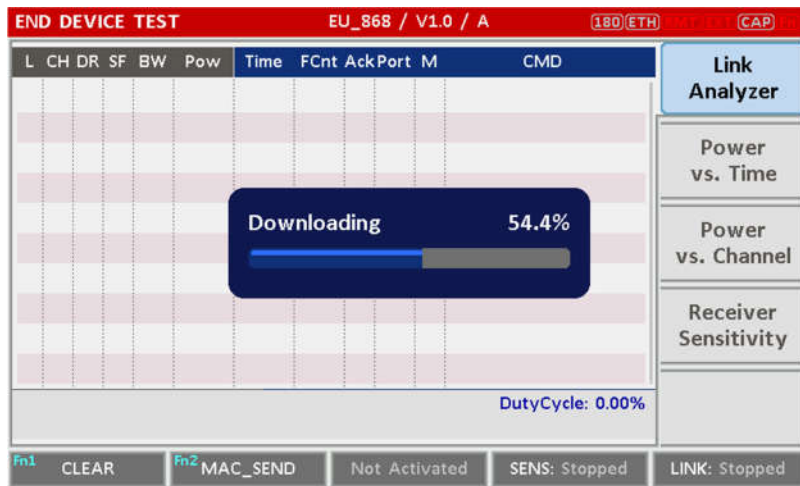

Fig 2.18 Firmware Upgrade Screen

- 6) After upgrading completed, reboot RWC5020A and check the software version in the system configuration screen.

CAUTION: If upgrading fails, turn on RWC5020A in Emergency Upgrade Mode and upgrade firmware again. Refer to “Emergency Firmware Upgrade Procedure”.

Emergency Firmware Upgrade Procedure

- 1) If Normal Firmware Upgrade Procedure fails during upgrading, the internal memory may be damaged. In this case, RWC5020A may not boot correctly. Then RWC5020A must be upgraded in Emergency Upgrade Mode.

- 2) Turn off RWC5020A. While keeping **RUN** key pressed, turn on RWC5020A. Then RWC5020A will boot in Emergency Upgrade Mode as the following figure.
- 3) Make direct connection between a remote PC and RWC5020A using a crossover cable and wait until IP address of RWC5020A will be displayed on the screen.
- 4) Follow the steps 3) to 6) of Normal Firmware Upgrade Procedure.



Fig 2.19 RWC5020A Boot Screen of Emergency Upgrade Mode

2.8 Save/Recall

The SAVE and RECALL functions allow you to store different instrument setups and retrieve them later. By saving test setups, you can save time by eliminating the task of re-configuring the instrument. The instrument supports up to 10 save/recall sets.

2.8.1 Save Method

Make any changes to the instrument that you want to SAVE in a memory. Then press **Fn** + **RECALL SAVE** key to execute SAVE pop-up screen as the following figure. Select SAVE buffer number and press **ENTER** key.

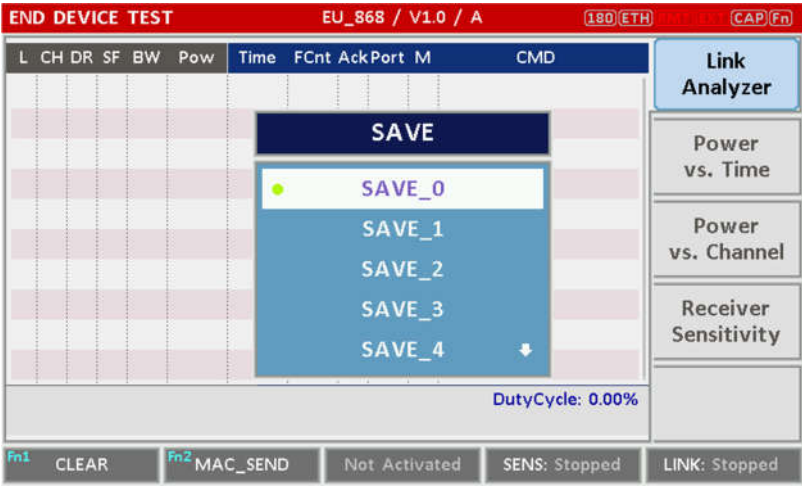

Fig 2.20 Screen of Parameter Configuration SAVE

2.8.2 Recall Method

Then press **RECALL SAVE** key to execute RECALL pop-up screen as following figure. Select RECALL buffer number and press **ENTER** key. The first RECALL buffer is RESET. If you select it, the instrument will be reset, i.e., factory reset.

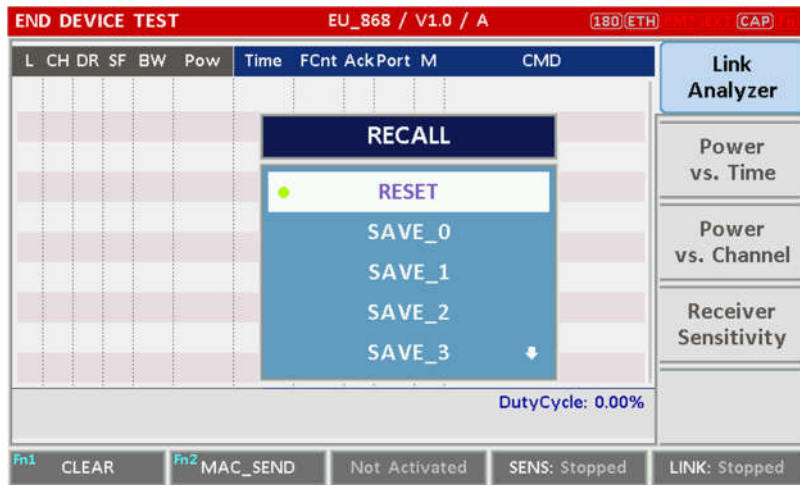

Fig 2.21 Screen of Parameter Configuration RECALL

2.8.3 Selection of Boot Configuration

When restarting the system, one of saved configuration will be retrieved. To define saved configuration for booting, press **SYSTEM** key and modify **BOOT_BY** to desired RECALL buffer number on the system configuration screen.



Fig 2.22 Screen of Configuration Setup for Boot

III. Functional Operation

This section describes the basic concepts and details of operating RWC5020A LoRa Tester. Understanding the basic concept of your RWC5020A may help you use it effectively.

- 3.1 Parameter Configuration and Basic Setup for EDT
- 3.2 Activation Procedure for EDT
- 3.3 Usage of Link Analyzer for EDT
- 3.4 Usage of Power vs. Time for EDT
- 3.5 Usage of Power vs. Channel for EDT
- 3.6 Usage of Receiver Sensitivity for EDT
- 3.7 Transmission of MAC Commands for EDT
- 3.8 Usage of Link Analyzer for Class B EDT
- 3.9 Parameter Configuration and Basic Setup for GWT
- 3.10 Activation Procedure for GWT
- 3.11 Usage of Link Analyzer for GWT
- 3.12 Usage of Power vs. Time for GWT
- 3.13 Usage of Power vs. Channel for GWT
- 3.14 Usage of Receiver Sensitivity for GWT
- 3.15 Transmission of MAC Commands for GWT
- 3.16 Usage of Link Analyzer for Class B GWT
- 3.17 Usage of Signal Generator for NST
- 3.18 Usage of Signal Analyzer for NST
- 3.19 Usage of MFG for NST

3.1 Parameter Configuration and Basic Setup for EDT

3.1.1 Overview

To create a link with an End Device and measure its performances, various protocol parameters as well as RF parameters should be configured in advance for users' purposes. This configuration is done in the parameter configuration screen as the following figure. Refer to 3.1.2 and 3.1.3 for descriptions of parameters.



Fig 3.1 EDT Parameter Configuration Screen - PROTOCOL



Fig 3.2 EDT Parameter Configuration Screen - RF

3.1.2 PROTOCOL Parameters

REGION

RWC5020A supports various regions [EU 868, EU 433, US 915, AU 915, CN 470, KR 920, AS 923, IN 865, RU 864]. Using this parameter, user could select the region to test.

OPERATOR

This parameter determines whether to enable LoRa operator-specific procedures and parameters. It is only applicable to South Korea (SKT) and China (ICA, CLAA) in the current version of firmware.

PROTOCOL_VER

This parameter defines the version of LoRaWAN protocol to be emulated by RWC5020A.

CLASS

There are three different classes in LoRa device. Class A is Bi-directional End Devices, Class B is Bi-directional End Devices with scheduled receive slots, and Class C is Bi-directional End Devices with maximal receive slots. This parameter defines the class mode of RWC5020A.

ACTIVATION

LoRaWAN defines two types of Activation procedures (OTAA, ABP). This parameter defines the activation mode of RWC5020A.

APP_KEY

The APP_KEY is an AES-128 root key specific to the End Device. Whenever an End Device joins a network via over-the-air activation, the APP_KEY is used to derive the session keys NwkSKey and AppSKey specific for that End Device to encrypt and verify network communication and application data. This parameter must be set to the same value as the APP_KEY on DUT.

CHECK_EUI

This parameter decides whether or not to compare DEV_EUI and APP_EUI during activation. If this parameter is ON, RWC5020A (Gateway/Server) compares DEV_EUI and APP_EUI and accepts only if the value is equal to the same.

DEV_EUI

The DEV_EUI is a globally unique End Device identifier. The DEV_EUI is stored in the End Device before the activation procedure is executed. If the CHECK_EUI is ON, this parameter must be set as the same value stored on the DUT.

APP_EUI

The APP_EUI is a global application ID in IEEE EUI64 address space that uniquely identifies the entity able to process the Join-request frame. The APP_EUI is stored in the End Device before the activation procedure is executed. If the CHECK_EUI is ON, this parameter must be set as the same value stored on the DUT.

DEV_ADDR

During the activation, the gateway assigns DEV_ADDR value to the End Device. If activation mode is ABP, this parameter must be set as the same value stored on the DUT. If activation mode is OTAA, this parameter value is used to generate Join-accept message.

APPS_KEY

APPS_KEY is used to encrypt and verify application data between Gateway and End Device. This value is derived from APP_KEY during OTAA. If activation mode is ABP, this parameter must be set as the same value stored on the DUT.

NWKS_KEY

NWKS_KEY is used to encrypt and verify network data between Gateway and End Device. This value is derived from APP_KEY during OTAA. If activation mode is ABP, this parameter must be set as the same value stored on the DUT.

UPDATE_FCNT

This parameter determines the initial value of FCNT before activation procedure and also updates FCNT values after activation.

ADR

LoRa network allows the End Devices to individually use any of the possible data rates. This feature is used by the LoRaWAN to adapt and optimize the data rate of static End Devices. This is referred to as Adaptive Data Rate (ADR) and when this is enabled the network will be optimized to use the fastest data rate possible.

DOWNLINK SLOT

When RWC5020A emulates Gateway/Server mode (EDT), it could respond to the uplink frame by downlink frame using RX1 window or RX2 window. Using this parameter, users can select RX window for testing the DUT.

NET_ID

The NET_ID is a network identifier to uniquely identify the network. This parameter value is used to generate Join-accept message.

RX1_DR_OFFSET

This parameter sets the offset between the uplink data rate and the downlink data rate used to communicate with the End Device on the first reception slot (RX1). This parameter value is used to generate Join-accept message.

RX2_DR

This parameter defines the data rate of a downlink using the second receive window. This parameter value is used to generate Join-accept message.

RECEIVE_DELAY

The first receive window RX1 opens RECEIVE_DELAY seconds after the end of the uplink modulation. This parameter value is used to generate Join-accept message.

LINK_MARGIN

This parameter is an 8-bit unsigned integer in the range of 0~254 indicating the link margin in dB of the last successfully received *LinkCheckReq* command. This parameter value is used to generate *LinkCheckAns* command.

GATEWAY_CNT

This parameter is the number of gateways that successfully received the last *LinkCheckReq*. This parameter value is used to generate *LinkCheckAns* command.

YEAR

This parameter indicates the year of RWC5020A time information. This parameter is used to generate *DeviceTimeAns* command and Beacon.

MONTH

This parameter indicates the month of RWC5020A time information. This parameter is used to generate *DeviceTimeAns* command and Beacon.

DAY

This parameter indicates the day of RWC5020A time information. This parameter is used to generate *DeviceTimeAns* command and Beacon.

HOUR

This parameter indicates the hour of RWC5020A time information. This parameter is used to generate *DeviceTimeAns* command and Beacon.

MINUTE

This parameter indicates the minute of RWC5020A time information. This parameter is used to generate *DeviceTimeAns* command and Beacon.

SECOND

This parameter indicates the second of RWC5020A time information. This parameter is used to generate *DeviceTimeAns* command and Beacon.

NETWORK

This parameter indicates the type of LoRa network, in other words the synchronization word to be used in LoRa modulation.

3.1.3 RF Parameters

TX POW

This parameter defines the output power of RWC5020A in dBm.

PATH LOSS

User can set the path loss between RF port of RWC5020A and DUT RF port. RWC5020A's real output power will be increased by this value to compensate path loss.

FREQ OFFSET

This parameter defines the frequency offset value in ppm.

TIME OFFSET

This parameter defines the time offset value in us.

CH MASK 0

This parameter defines the mask of channels to be used for LoRa communication, which is applicable only to regions of EU_868, EU_433, KR_920, AS_923, IN_865, and RU_865.

CH GROUP

This parameter defines the mask of the channels to be used for LoRa communication, which is applicable only to regions of US_915, AU_915, and CN_470.

RX2_FREQ

This parameter defines the frequency of a downlink using the second receive window (read only).

RX2_DR

This parameter defines the data rate of a downlink using the second receive window (read only).

DL_CH 00 ~ DL_CH 07

This parameter defines real channel frequency of each downlink channel index.

UL_CH 00 ~ UL_CH 07

This parameter defines real channel frequency of each uplink channel index.

UL_CH 64 ~ UL_CH 71

This parameter defines real channel frequency of each 500kHz uplink channel index.

3.2 Activation Procedure for EDT

3.2.1 Overview

RWC5020A supports both ways of activation of an End Device; Over The Air Activation (OTAA) and Activation By Personalization (ABP). This section describes how to configure parameters for OTAA and ABP respectively.

3.2.2 OTAA Procedure

1. [Parameter Window]
Press  key to open the parameter configuration screen and select PROTOCOL tap to configure MAC protocol parameters.
2. [Region]
Set REGION parameter as needed.
3. [Protocol Version]
Set PROTOCOL_VER to LoRaWAN1.0.2, LoRaWAN1.0.3 or LoRaWAN1.1.
4. [Activation Parameters]
For LoRaWAN V1.0.2 or V1.0.3,
 - 1) Set ACTIVATION parameter to OTAA.
 - 2) Set APP_KEY to the application key specific to an End Device.
 - 3) Set CHECK_EUI parameter to determine whether to check EUI of an End Device for activation.
If YES, both DEV_EUI and APP_EUI parameters shall be set to values specific to an End Device and RWC5020A will compare the EUI values with DUT and reject them if they do not match.
If NO, the RWC5020A copies these parameters from Join Accept packets. Therefore, user does not have to worry about these values.
 - 4) Set SET_TEST_MODE parameter to determine whether to force DUT to enter certification test mode by sending *Activated Test Mode* command after activation procedure.

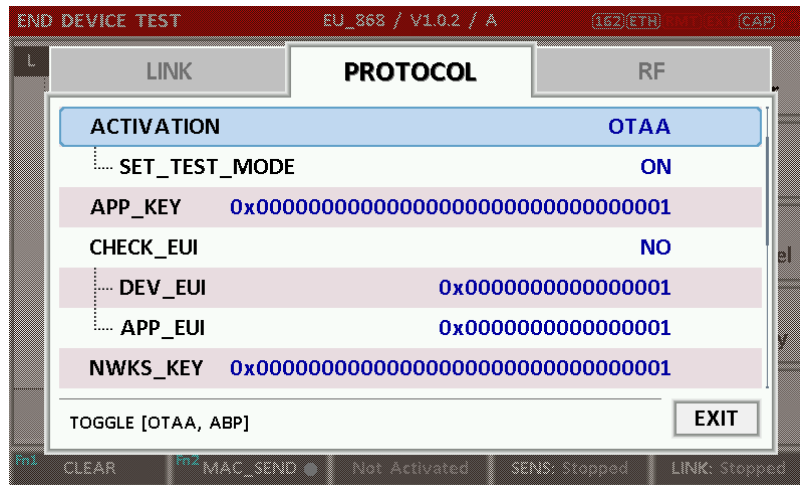

Fig 3.3 Parameters for OTAA (LoRaWAN V1.0)

For LoRaWAN V1.1,

- 1) Set ACTIVATION parameter to OTAA.
- 2) Set NWK_KEY and APP_KEY parameters specific to an End Device.
- 3) Set CHECK_EUI parameter to determine whether to check EUI of an End Device for activation.
If YES, both DEV_EUI and JOIN_EUI parameters shall be set to values specific to an End Device.
If NO, these parameters are ignored in activation procedure.
- 4) Set SET_TEST_MODE parameter to determine whether to force DUT to enter certification test mode by sending *Activated Test Mode* command after activation procedure.

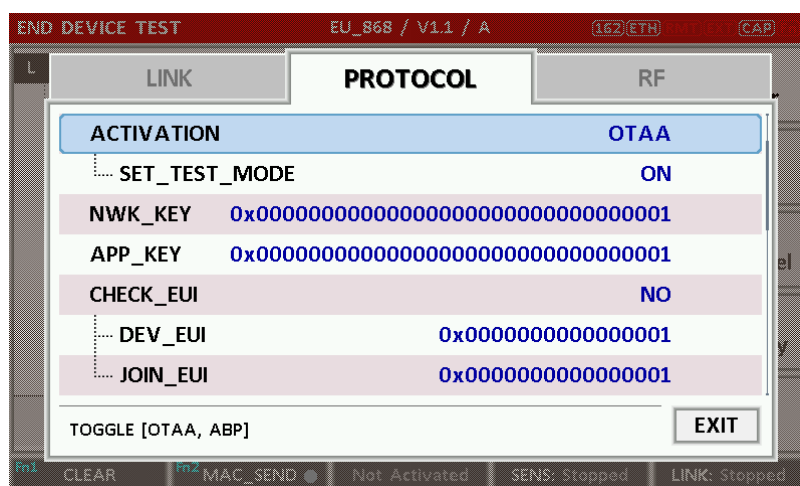

Fig 3.4 Parameters for OTAA (LoRaWAN V1.1)

5. [JoinAccept Parameters]

Set parameters of Join-accept message if needed as the following figure.



Fig 3.5 Parameters for Join-accept Message

6. [Downlink Slot]

Set DOWNLINK_SLOT parameter to RX1 or RX2 to determine a physical channel to be used for transmission by RWC5020A (Gateway/Server)

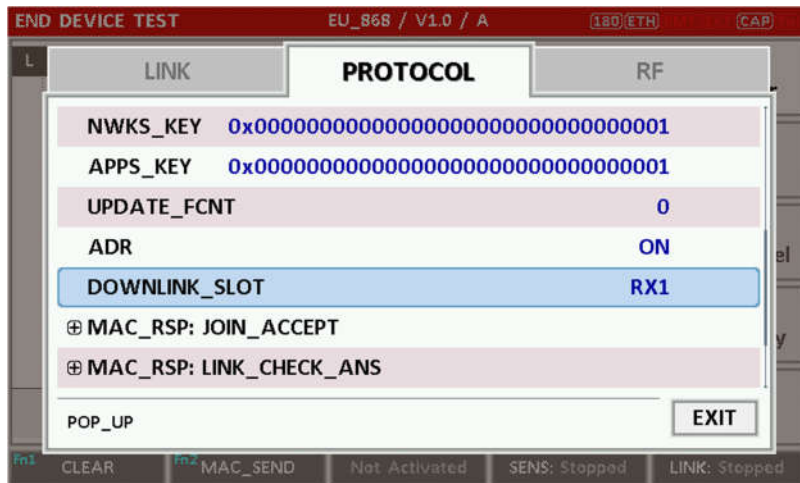

Fig 3.6 Selection of Downlink Slot

7. [RF Parameters Setup]

Select RF tap to configure RF parameters.

- 1) Set TX_POW and PATH_LOSS parameters if needed.
- 2) Set CH_MASK_0 or CH_GROUP to configure physical channels if needed. Then expand CHANNEL_INFO to configure channel information. This information is contained as CFList

parameter of a Join-accept message.



Fig 3.7 Channel Information in RF Parameters

3.2.3 ABP Procedure

1. [Parameter Window]

Press **PARAM** key to open the parameter configuration screen and select PROTOCOL tap to configure MAC protocol parameters.
2. [Region]

Set REGION parameter as needed.
3. [Protocol Version]

Set PROTOCOL_VER to LoRaWAN1.0.2, LoRaWAN1.0.3 or LoRaWAN1.1.
4. [Activation Parameters]

For LoRaWAN V1.0.2 or V1.0.3,

 - 1) Set ACTIVATION parameter to ABP.
 - 2) Set DEV_ADDR to a value specific to an End Device.
 - 3) Set NWKS_KEY and APPS_KEY parameters to the two session keys unique to an End Device.
 - 4) Set SET_TEST_MODE parameter to determine whether to force DUT to enter certification test mode by sending *Activated Test Mode* command after activation procedure.
 - 5) Set SET_CH_MASK parameter to determine whether to configure DUT's channel mask by sending *LinkADRReq* command after activation procedure, which is applicable only to regions of US_915, AU_915, and CN_470.

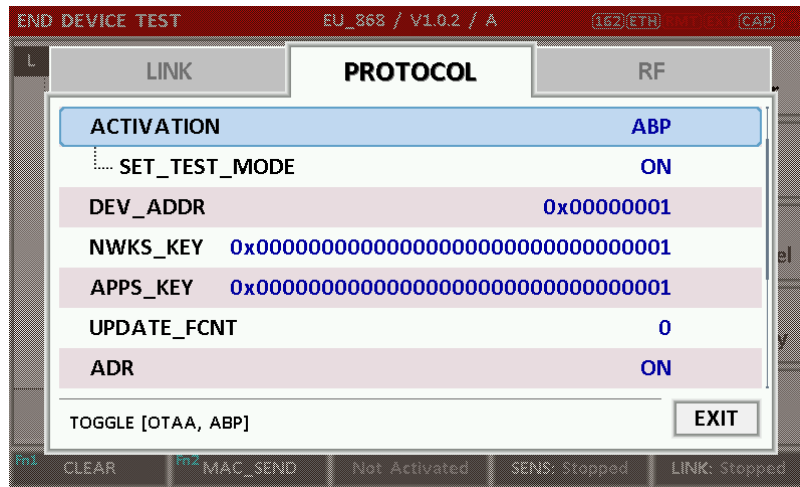

Fig 3.8 Parameters for ABP (LoRaWAN V1.0)

For LoRaWAN V1.1,

- 1) Set ACTIVATION parameter to ABP.
- 2) Set DEV_ADDR to a value specific to an End Device.
- 3) Set FNWKS_IKEY, SNWKS_IKEY, NWKS_EKEY and APPS_KEY parameters to the four session keys unique to an End Device.
- 4) Set SET_TEST_MODE parameter to determine whether to force DUT to enter certification test mode by sending *Activated Test Mode* command after activation procedure.

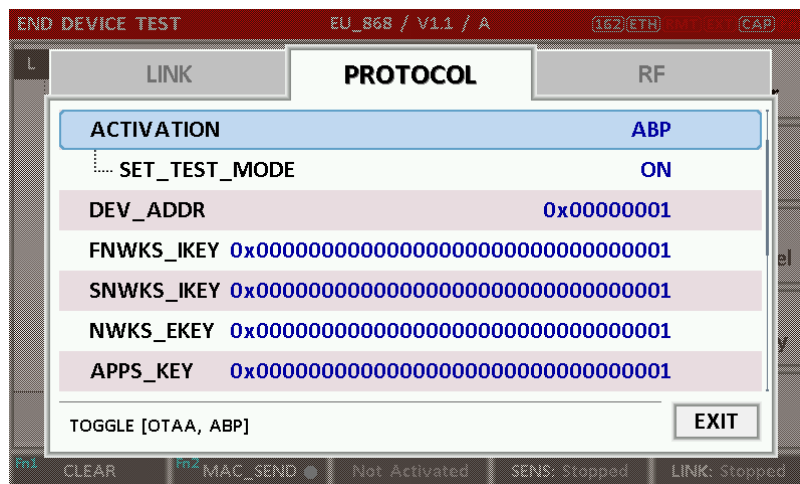

Fig 3.9 Parameters for ABP (LoRaWAN V1.1)

5. [RF Parameters Setup]
Refer to 3.2.2 for RF setup.

3.3 Usage of Link Analyzer for EDT

3.3.1 Overview

RWC5020A provides a function of Link Analyzer for EDT and GWT. In EDT, Link Analyzer helps to create a link between RWC5020A and an End Device Under Test and to analyze the protocol messages.

3.3.2 Test Procedure

1. [Main Menu selection]

Set the Main Menu to EDT referring to 2.3.1.

2. [Sub Menu selection]

Set the Sub Menu to Link Analyzer referring to 2.3.2.

3. [Parameter configuration]

Press  key to open the parameter configuration screen. Configure protocol parameters or RF parameters for users' purposes in PROTOCOL tap or RF tap respectively. Refer to 3.1 and 3.2 for details.







4. [DUT connection setup]

Connect the RF port of RWC5020A to the RF port of DUT with an RF cable for conduction test. For radiation test, use a special test environment, e.g., a shield box or an antenna. In the latter case, it is recommended to use a test jig for DUT positioning to guarantee the reliability and repeatability of test and measurement results.

5. [Execution]

Press  key, and RWC5020A will be waiting for a message from the DUT. As soon as communication starts, link messages between DUT and RWC5020A will be displayed in real time. On the right bottom side of the screen the link status is displayed as 'LINK: Running' or 'LINK: Stopped'. Refer to 2.5.4 for descriptions of the Link Analyzer screen.

6. [Analysis and utilization]

Pressing  or  key moves the cursor location to the link message window. Rotating the rotary knob shows the raw data of the current cursor position at the bottom of the screen in hexadecimal format. Rotating the rotary knob with  key pressed scrolls the screen by page-up or page-down. Pressing  or  key with  key pressed scrolls the screen in horizontal direction.

7. [Switch to other Sub Menu]

While the link status is running, switching to other Sub Menu is available. All data in Link Analyzer,

Power vs. Time, and Power vs. Channel are synchronized each other, since RWC5020A analyzes protocol messages and also measures RF power in processing the received frames.

3.3.3 Parameters

RWC5020A provides a function of sending a MAC command to DUT, defined in the LoRaWAN Specification, at the time users want. All parameters for each MAC command are configurable. Refer to 3.7 for details.

MAC CMD TYPE

This parameter defines the type of MAC command to be transmitted: confirmed or unconfirmed.

MAC CMD FIELD

This parameter defines the type of field where MAC command is stored in a frame: payload or option field.

NUM OF CMD

This parameter defines the number of MAC commands to be transmitted in a single frame. RWC5020A allows up to three MAC commands in a single frame.

INSTANT MAC CMD1 ~ 3

This parameter defines which MAC command will be transmitted.

INSTANT MAC CMD: DEV STATUS

This parameter is for sending *DevStatusReq* command to DUT, which expects *DevStatusAns* command from it. *DevStatusReq* command requests the status of the End Device and does not have any parameter.

INSTANT MAC CMD: LINK ADR

This parameter is for sending *LinkADRReq* command to DUT, which expects *LinkADRAns* command from it. *LinkADRReq* command requests the End Device to change data rate, transmit power, repetition rate or channel.

ADR DR

This parameter is the requested data rate of End Device for uplink message.

ADR_TXPOW

This parameter is the requested output power of End Device for uplink message.

ADR_CH_MASK

This parameter encodes the channels usable for uplink access. A bit in the CH_MASK field set to 1 means that the corresponding channel can be used for uplink transmissions.

ADR_MASK_CTRL

This parameter controls the interpretation of the previously defined CH_MASK bit mask. It controls the block of 16 channels to which the CH_MASK applies. It can also be used to globally turn on or off all channels using specific modulation.

ADR_NB_TRANS

This parameter is the number of transmissions for each uplink message.

INSTANT MAC CMD: DUTY CYCLE

This parameter is for sending *DutyCycleReq* command to DUT, which expects *DutyCycleAns* command from it. *DutyCycleReq* command sets the maximum aggregated transmit duty-cycle of the End Device.

MAX_DUTY_CYCLE

This parameter is used by the network coordinator to limit the maximum aggregate transmit duty cycle of an End Device.

INSTANT MAC CMD: RX PARAM SETUP

This parameter is for sending *RXParamSetupReq* command to DUT, which expects *RXParamSetupAns* command from it. *RXParamSetupReq* command sets the reception slots parameters.

RX1_DR_OFFSET

This parameter sets the offset between the uplink data rate and the downlink data rate used to communicate with End Device on the first reception slot (RX1).

RX2_FREQ

This parameter defines the frequency of a downlink using the second receive window.

RX2_DR the data rate of a downlink using the second receive window

This parameter defines the data rate of a downlink using the second receive window.

INSTANT MAC CMD: TX PARAM SETUP

This parameter is for sending *TXParamSetupReq* command to DUT, which expects *TXParamSetupAns* command from it. *TXParamSetupReq* command is used by the network server to set the maximum allowed dwell time and Max EIRP of End Device, based on local regulations.

MAX EIRP

This parameter corresponds to an upper bound on the device’s radio transmit power. The device is not required to transmit at that power, but shall never radiate more that this specified EIRP.

Coded Value	0	1	2	3	4	5	6	7	8	9	10	11	12	13	14	15
Max EIRP (dBm)	8	10	12	13	14	16	18	20	21	24	26	27	29	30	33	36

UL DWELL TIME

This parameter corresponds to the maximum allowed dwell time for uplink transmissions.

DL DWELL TIME

This parameter corresponds to the maximum allowed dwell time for downlink transmissions.

INSTANT MAC CMD: NEW CHANNEL

This parameter is for sending *NewChannelReq* command to DUT, which expects *NewChannelAns* command from it. *NewChannelReq* command creates or modifies the definition of a radio channel.

NEW CH MODE

This parameter can be used to either modify the parameters of an existing bidirectional channel or to create a new one. To create or modify the channel, set this parameter as ‘CREATE’. To delete the channel, set this parameter as ‘DELETE’

NEW CH INDEX

This parameter is the index of the channel being created or modified.

NEW CH MAX DR

This parameter designates the highest uplink data rate allowed on this channel.

NEW CH MIN DR

This parameter designates the lowest uplink data rate allowed on this channel.

INSTANT MAC CMD: DL CHANNEL

This parameter is for sending *DIChannelReq* command to DUT, which expects *DIChannelAns* command from it. *DIChannelReq* command sets the network to associate a different downlink frequency to the RX1 slot.

DL CH INDEX

This parameter is the index of the channel whose downlink frequency is modified.

DL_CH_FREQ

This parameter is the corresponding downlink frequency value of a 24 bits unsigned integer. The actual downlink frequency in Hz is $100 \times \text{DL_CH_FREQ}$.

INSTANT_MAC_CMD: RX TIMING SETUP

This parameter is for sending *RXTimingSetupReq* command to DUT, which expects *RXTimingSetupAns* command from it. *RXTimingSetupReq* command sets the timing of the of the reception slots.

RECEIVE_DELAY

The first receive window RX1 opens RECEIVE_DELAY seconds after the end of the uplink modulation.

INSTANT_MAC_CMD: USER DEFINED

This parameter is for sending a user-defined command to DUT, which includes user-defined data of user-defined length.

PAYLOAD_TYPE

If it is set as '0000_0000', the frame payload will be set all zero bytes. If it is set as '1111_1111', the frame payload will be set all one bytes. If it is set as '1111_0000', frame payload will be set 0xF0 bytes. If it is set as '1010_1010', frame payload will be set 0xAA bytes. If it is set as PRBS, frame payload will be set pseudo random bytes. If it is set as 'USER', frame payload will be set as PAYLOAD parameter values.

FPORT

This parameter defines the FPort number of a user-defined MAC Command.

PAYLOAD_SIZE

This parameter defines the size of payload of a user-defined MAC Command.

PAYLOAD

This parameter defines the content of payload in hexadecimal format and appears only when PAYLOAD_TYPE is 'USER'.

INSTANT_MAC_CMD: ACTIVATE_TM

This parameter is for sending *Activate test mode* command to DUT, which starts test mode when 4 bytes payload with value 0x01010101 is sent to DUT.

INSTANT MAC CMD: DEACTIVATE TM

This parameter is for sending *Deactivate test mode* command to DUT, which stops test mode and the DUT goes back to normal applicative operation.

INSTANT MAC CMD: CONFIRMED TM

This parameter is for sending *Confirmed frames* command to DUT, which requests DUT to send the consequent uplink packets with a message type 'Confirmed'. It may be meaningful only after certification test mode is enabled by *Activate test mode* command.

INSTANT MAC CMD: UNCONFIRMED TM

This parameter is for sending *Unconfirmed frames* command to DUT, which requests DUT to send the consequent uplink packets with a message type 'Unconfirmed'. It may be meaningful only after certification test mode is enabled by *Activate test mode* command.

INSTANT MAC CMD: ECHO REQUEST TM

This parameter is for sending *EchoRequest* command to DUT, which requests DUT to reply with *EchoResponse*. It may be meaningful only after certification test mode is enabled by *Activate test mode* command.

ECHO LEN

This parameter indicates the length of payload in *EchoRequest* command.

INSTANT MAC CMD: TRIGGER JOIN REQ TM

This parameter is for sending *Trigger Join Request* command to DUT, which requests DUT to send *Join-request*. It may be meaningful only after certification test mode is enabled by *Activate test mode* command.

INSTANT MAC CMD: ENABLE CW MODE TM

This parameter is for sending *Enable Continuous Wave Mode* command to DUT, which requests DUT to send continuous wave (CW) signal based on the values in the payload. It may be meaningful only after certification test mode is enabled by *Activate test mode* command.

CW TIMEOUT

This parameter indicates the timeout for CW transmission.

CW FREQ

This parameter indicates the frequency of CW signal.

CW POW

This parameter indicates the power of CW signal.

INSTANT MAC CMD: BEACON_FREQ

This parameter is for sending *BeaconFreqReq* command to DUT, which expects *BeaconFreqAns* command from it. *BeaconFreqReq* command sets the network to associate new beacon frequency

BEACON_FREQ

This parameter is the corresponding beacon frequency value of a 24 bits unsigned integer.

INSTANT MAC CMD: PING_SLOT_CH_REQ

This parameter is for sending *PingSlotChannelReq* command to DUT, which expects *PingSlotFreqAns* command from it. *PingSlotChannelReq* command modifies the frequency and/or the data rate on which the end-device expects the downlink pings

PING_DR

This parameter is the index of the Data Rate used for the ping-slot downlinks.

PING_FREQ

This parameter is the corresponding ping channel frequency value of a 24 bits unsigned integer.

The actual ping channel frequency in Hz is $100 \times \text{PING_FREQ}$.

INSTANT MAC CMD: FORCE_REJOIN

This parameter is for sending *ForceRejoinReq* to DUT, which expects no answer from it. With the *ForceRejoinReq* command, the network asks a device to immediately transmit a Rejoin-Request Type 0 or type 2 message with a programmable number of retries, periodicity and data rate.

REJOIN_DR

This parameter is the data rate of Rejoin-Request.

REJOIN_TYPE

This parameter is the type of Rejoin-Request.

REJOIN_RETRY

This parameter is the total number of times DUT will retry Rejoin-Request.

REJOIN_PERIOD

This parameter is the delay between retransmissions. The actual delay is $32 \times 2^{\text{Period}} + \text{Rand32}$ seconds, where Rand32 is a pseudo-random number in the [0:32] range.

INSTANT MAC CMD: REJOIN SETUP

This parameter is for sending *RejoinParamSetupReq* command to DUT, which expects *RejoinParamSetupAns* command from it. *RejoinParamSetupReq* command sets the network to request DUT to periodically send a *RejoinReq* Type 0 message with a programmable periodicity defined as a time of a number of uplinks.

REJOIN MAX TIME N

This parameter is the max time T. DUT must send a Rejoin-Request Type 0 at least every 2^{T+10} seconds.

REJOIN MAX CNT N

This parameter is the max count C. DUT must send a Rejoin-Request Type 0 at least every 2^{C+4} uplink messages.

INSTANT MAC CMD: ADR SETUP

This parameter is for sending *ADRParamSetupReq* command to DUT, which expects *ADRParamSetupAns* command from it. *ADRParamSetupReq* command allows changing the *ADR_ACK_LIMIT* and *ADR_ACK_DELAY* parameters defining the ADR back-off algorithm.

ADR LIMIT EXP

This parameter is used to set *ADR_ACK_LIMIT* parameter value:

$$\text{ADR_ACK_LIMIT} = 2^{\text{ADR_LIMIT_EXP}}$$

ADR DELAY EXP

This parameter is used to set *ADR_ACK_DELAY* parameter value:

$$\text{ADR_ACK_DELAY} = 2^{\text{ADR_DELAY_EXP}}$$

DOWNLINK SLOT

When RWC5020A emulates Gateway/Server mode (EDT), it could respond to the uplink frame by downlink frame using RX1 window or RX2 window. Using this parameter, users can select RX window for testing the DUT.

MIC ERR DISPLAY

This parameter determines whether to display erroneous frames in Link Analyzer screen.

PARAMETER DISPLAY

This parameter determines the list of protocol parameters to be displayed on the Link Analyzer screen. Each parameter can be switched on or off; DR, POW, TIME, DELAY, FCNT, ADR, ACK,





ADRACKREQ, FPENDING, CLASS_B, PORT, DWELL and MSG_TYPE.

3.4 Usage of Power vs. Time for EDT

3.4.1 Overview

RWC5020A provides a function of Power vs. Time measurement for EDT and GWT. In EDT, Power vs. Time measurement helps to create a link between RWC5020A and an End Device Under Test and to measure the received power with respect to data rates.

3.4.2 Test Procedure

1. [Main Menu selection]
Set the Main Menu to EDT referring to 2.3.1.
2. [Sub Menu selection]
Set the Sub Menu to Power vs. Time referring to 2.3.2.
3. [Parameter configuration]
Press  key to open the parameter configuration screen. Configure protocol parameters or RF parameters for users' purposes in PROTOCOL tap or RF tap respectively. Refer to 3.1 and 3.2 for details.
4. [DUT connection setup]
Connect the RF port of RWC5020A to the RF port of DUT with an RF cable for conduction test. For radiation test, use a special test environment, e.g., a shield box or an antenna. In the latter case, it is recommended to use a test jig for DUT positioning to guarantee the reliability and repeatability of test and measurement results.
5. [Execution]
Press  key, and RWC5020A will be waiting for a message from the DUT. As soon as communication starts, the measured power will be displayed on the screen in real time. On the right bottom side of the screen the link status is displayed as 'LINK: Running' or 'LINK: Stopped'. Refer to 2.5.5 for descriptions of the Power vs. Time screen.
6. [Analysis and utilization]
Pressing  or  key moves the cursor location to the measurement window, and the cursor changes to the marker. Rotating the rotary knob shows all measured values of the current marker position at the top of the screen.
7. [Switch to other Sub Menu]
While the link status is running, switching to other Sub Menu is available. All data in Link Analyzer, Power vs. Time, and Power vs. Channel are synchronized each other, since RWC5020A analyzes

protocol messages and also measures RF power in processing the received frames.

3.4.3 Parameters

SCALE

It determines scaling of Y-axis. AUTO scales automatically for each measurement and MANUAL keeps the current scaling according to MAX_Y and MIN_Y values.

MAX_Y

In case of MANUAL scaling, the maximum value of Y-axis can be set.

MIN_Y



In case of MANUAL scaling, the minimum value of Y-axis can be set.

3.5 Usage of Power vs. Channel for EDT

3.5.1 Overview

RWC5020A provides a function of Power vs. Channel measurement for EDT and GWT. In EDT, Power vs. Channel measurement helps to create a link between RWC5020A and an End Device Under Test and to measure the received power with respect to RF channels.

3.5.2 Test Procedure

1. [Main Menu selection]
Set the Main Menu to EDT referring to 2.3.1.
2. [Sub Menu selection]
Set the Sub Menu to Power vs. Channel referring to 2.3.2.
3. [Parameter configuration]
Press  key to open the parameter configuration screen. Configure protocol parameters or RF parameters for users' purposes in PROTOCOL tap or RF tap respectively. Refer to 3.1 and 3.2 for details.
4. [DUT connection setup]
Connect the RF port of RWC5020A to the RF port of DUT with an RF cable for conduction test. For radiation test, use a special test environment, e.g., a shield box or an antenna. In the latter case, it is recommended to use a test jig for DUT positioning to guarantee the reliability and repeatability of test and measurement results.
5. [Execution]
Press  key, and RWC5020A will be waiting for a message from the DUT. As soon as communication starts, the measured power will be displayed on the screen in real time. On the right bottom side of the screen the link status is displayed as 'LINK: Running' or 'LINK: Stopped'. Refer to 2.5.6 for descriptions of the Power vs. Channel screen.
6. [Switch to other Sub Menu]
While the link status is running, switching to other Sub Menu is available. All data in Link Analyzer, Power vs. Time, and Power vs. Channel are synchronized each other, since RWC5020A analyzes protocol messages and also measures RF power in processing the received frames.

3.5.3 Parameters

SCALE

It determines scaling of Y-axis. AUTO scales automatically for each measurement and MANUAL keeps the current scaling according to MAX_Y and MIN_Y values.

MAX_Y

In case of MANUAL scaling, the maximum value of Y-axis can be set.

MIN_Y





In case of MANUAL scaling, the minimum value of Y-axis can be set.

3.6 Usage of Receiver Sensitivity for EDT

3.6.1 Overview

Receiver Sensitivity is a function of testing the receiver performance of DUT. RWC5020A sweeps its power level from the start value to the stop value with the step value and checks whether DUT functions properly, and stops immediately after DUT does not function properly.

3.6.2 Test Procedure

1. [Main Menu selection]
Set the Main Menu to EDT referring to 2.3.1.
2. [Sub Menu selection]
Set the Sub Menu to Receiver Sensitivity referring to 2.3.2.
3. [Parameter configuration]
Press  key to open the parameter configuration screen. Configure protocol parameters or RF parameters for users' purposes in PROTOCOL tap or RF tap respectively. Refer to 3.1 and 3.2 for details. In SENSITIVITY tap, all parameters can be configured to be used in the execution of sensitivity test.
4. [DUT connection setup]
Connect the RF port of RWC5020A to the RF port of DUT with an RF cable for conduction test. For radiation test, use a special test environment, e.g., a shield box or an antenna. In the latter case, it is recommended to use a test jig for DUT positioning to guarantee the reliability and repeatability of test and measurement results.
5. [Execution]
Press  key, and RWC5020A will be waiting for a message for activation from the DUT. As soon as the activation procedure finishes, RWC5020A starts the sensitivity test from the start power value, checks whether DUT functions properly at each power step value, stops immediately after DUT does not function properly, and shows the final results. On the right bottom side of the screen the sensitivity status is displayed as 'SENS: Running' or 'SENS: Stopped' as well as the link status. Refer to 2.5.7 for descriptions of the Receiver Sensitivity screen.
6. [Analysis and utilization]
Pressing  or  key moves the cursor location to the sensitivity window, and the cursor changes to the marker. Rotating the rotary knob shows all measured values of the current marker position at the top of the screen.

7. [Switch to other Sub Menu]

While the sensitivity status is running, switching to other Sub Menu is available. All data in Link Analyzer, Power vs. Time, and Power vs. Channel are synchronized each other, since RWC5020A analyzes protocol messages and also measures RF power in processing the received frames.

3.6.3 Parameters

SCENARIO

This is the test scenario of the sensitivity test. In 'NORMAL_UL', DUT should send unconfirmed or confirmed uplink messages periodically and the Tester sends confirmed downlink messages and checks the flag of acknowledgement in DUT frames in order to count errors. In 'CERTI_ECHO', DUT should enter the test mode by the Tester's activation command and the Tester will use EchoRequest/EchoResponse in order to count errors.

PACKET_NUM

This is the packet number of tests at each test point. Increasing it the test result may have higher resolution but the testing time may become longer.

START_POW

This defines the start value of POWER sweep.

STOP_POW

This defines the stop value for POWER sweep (read only).

STEP_POW

This defines the step value for POWER sweep.

NUM_POW

This defines the number of power values for POWER sweep.

TARGET_PER

This is a parameter to set user's target PER. The test sweeps fully in the range of POWER until DUT does not satisfy TARGET_PER.

DOWNLINK_SLOT

This is a parameter to select RX window of for testing the DUT.

TARGET_DR

This is a parameter to determine the DR by sending MAC command before before Sensitivity Test starts. *LinkADDRReq* will be sent in case of RX1 and *RXParamSetReq* will be sent in case of RX2.

DL_PACKET

This is a parameter to define the contents of downlink packets to be used in 'NORMAL_UL' scenario.

PAYLOAD_TYPE

If it is set as '0000_0000', the frame payload will be set all zero bytes. If it is set as '1111_1111', the frame payload will be set all one bytes. If it is set as '1111_0000', frame payload will be set 0xF0 bytes. If it is set as '1010_1010', frame payload will be set 0xAA bytes. If it is set as PRBS, frame payload will be set pseudo random bytes. If it is set as 'USER', frame payload will be set as PAYLOAD parameter values.

FPORT

This parameter defines the FPort number of a user-defined MAC Command.

PAYLOAD_SIZE

This parameter defines the size of payload of a user-defined MAC Command.

PAYLOAD

This parameter defines the content of payload in hexadecimal format and appears only when PAYLOAD_TYPE is 'USER'.

ECHO

This is a parameter to select the type of downlink packets to be used in 'CERTI_ECHO' scenario. ACK is a simple acknowledgement and USER_DEFINED can be any format of packets with the following parameters.

In CERTI_ECHO scenario, PAYLOAD_SIZE, PAYLOAD_TYPE and PAYLOAD are configurable.

3.7 Transmission of MAC Commands for EDT

3.7.1 Overview

After the activation procedure is completed successfully, RWC5020A can send any MAC command to DUT as defined on Parameter configuration.

3.7.2 Test Procedure

1. [Activation]

Follow the steps referring to 3.3 to complete the activation successfully.

2. [MAC command selection]

Press **PARAM** key to open the parameter configuration screen and move to LINK tap. Define the number of MAC commands to be sent in a single frame as NUM_OF_CMD and select a MAC command to be sent from the list of INSTANT_MAC_CMD and configure its parameters. Refer to 3.3.3 for details about MAC commands. Close the parameter configuration screen.

3. [MAC command transmission]

Press **Fn** + **2 B** key to select 'MAC_SEND' button on the bottom of the screen. Then RWC5020A will wait a new message from DUT to send the MAC command at the next downlink channel.



Fig 3.10 Example of a single MAC command selection

END DEVICE TEST											EU_868 / V1.0 / A		180 ETH	CAP
L	CH	DR	SF	BW	Pow	Time	FCnt	AckPort	M	CMD	Link Analyzer			
U	0	0	12	125	9.5	5.09s	0003	0	099	U	DataUp	Power vs. Time		
U	2	0	12	125	9.5	5.09s	0004	0	099	U	DataUp			
U	0	0	12	125	9.5	5.09s	0005	0	099	U	DataUp			
U	2	0	12	125	9.5	5.09s	0006	0	099	U	DataUp			
D	2	0	12	125	-50.0	----	0000	0	000	U	LinkADRReq	Power vs. Channel		
U	2	0	12	125	9.5	4.53s	0007	0	000	U	LinkADRAns			
U	0	0	12	125	9.5	5.52s	0008	0	099	U	DataUp	Receiver Sensitivity		
U	1	0	12	125	9.5	5.03s	0009	0	099	U	DataUp			
U	2	0	12	125	9.5	5.03s	000A	0	099	U	DataUp			
U	1	0	12	125	9.5	5.03s	000B	0	099	U	DataUp			
Pow=1, DR=1, Mask=1											DutyCycle: 28.06%			
40 01 00 00 00 80 07 00 00 03 07 CA 60 D5 92														
Fn1 CLEAR		Fn2 MAC_SEND		Activated		SENS: Stopped		LINK: Running						

Fig 3.11 Example of a single MAC command transmission (Fn + 2 B)

END DEVICE TEST											EU_868 / V1.0 / A		180 ETH	CAP
L	CH	DR	SF	BW	Pow	Time	FCnt	AckPort	M	CMD	Link Analyzer			
LINK											PROTOCOL		RF	
NUM_OF_CMD													2	
INSTANT_MAC_CMD1											RX_PARAM_SETUP			
RX1_DR_OFFSET													0	
RX2_FREQ											869.525000		MHz	
RX2_DR													DR_0	
INSTANT_MAC_CMD2											LINK_ADR			
ADR_DR													0	
1 ~ 3													EXIT	
Fn1 CLEAR		Fn2 MAC_SEND		Activated		SENS: Stopped		LINK: Running						

Fig 3.12 Example of multiple MAC commands selection

END DEVICE TEST											EU_868 / V1.0 / A		180 ETH	CAP
L	CH	DR	SF	BW	Pow	Time	FCnt	AckPort	M	CMD	Link Analyzer			
U	0	0	12	125	9.4	5.09s	0004	0	099	U	DataUp	Power vs. Time		
U	0	0	12	125	9.4	5.09s	0005	0	099	U	DataUp			
U	0	0	12	125	9.4	5.09s	0006	0	099	U	DataUp			
D	0	0	12	125	-50.0	----	0000	0	000	U	RXParamSetReq			
D											LinkADRReq	Power vs. Channel		
U	1	0	12	125	9.4	4.69s	0007	0	000	U	RXParamSetAns			
U											LinkADRAns	Receiver Sensitivity		
U	1	0	12	125	9.5	5.36s	0008	0	099	U	DataUp			
U	0	0	12	125	9.5	5.03s	0009	0	099	U	DataUp			
U	1	0	12	125	9.5	5.03s	000A	0	099	U	DataUp			
RX1DRoffset=1, RX2DR=1, CH=1											DutyCycle: 27.94%			
40 01 00 00 00 80 07 00 00 05 07 03 07 20 4F B4 28														
Fn1 CLEAR		Fn2 MAC_SEND		Activated		SENS: Stopped		LINK: Running						

Fig 3.13 Example of multiple MAC commands transmission (Fn + 2 B)

3.8 Usage of Link Analyzer for Class B EDT

3.8.1 Overview

This section shows how to connect Class B End Device and configure related parameters.

3.8.2 Test Procedure

1. [Parameter Configuration]

Press **PARAM** key to open the parameter configuration screen and move to PROTOCOL tap. Select CLASS as B. Then read-only parameters appear such as PING_PERIODICITY and PING_DR, which may be updated by DUT parameters.

2. [Activation]

Refer to 3.2 to configure parameters for activation.

3. [Execution]

Press **RUN** key, and RWC5020A will be waiting for a message for activation from the DUT. As soon as the activation procedure finishes, RWC5020A starts the beacon timer, which counts up every second from 0 to 127, shown as RUN_xx at the right bottom of the screen. Whenever the timer sets to zero, a beacon is sent out. The following figure is an example of communication between Class B End Device and RWC5020A, showing related MAC commands and Class B flag.

4. [MAC command transmission through PING slot]

Press **PARAM** key to open the parameter configuration screen and move to LINK tap. Select DOWNLINK_SLOT as PING. The selected MAC command will be sent at the next PING slot. Refer to 3.7 for details of MAC command transmission, which is also applicable to Class B.

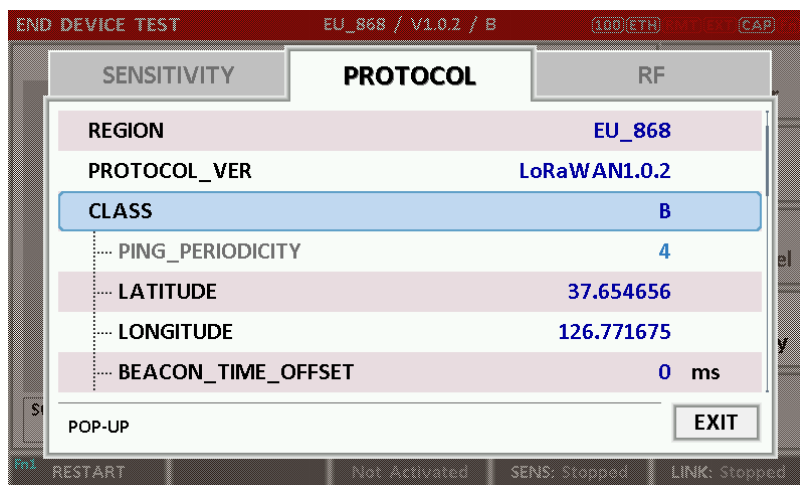

Fig 3.14 Selection of Class B in Parameter Configuration

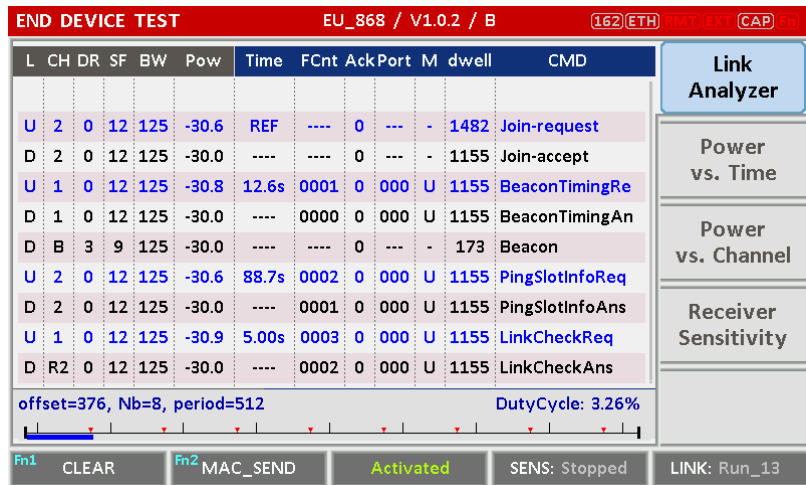

Fig 3.15 Example of communication with Class B End Device



Fig 3.16 Selection of DOWNLINK_SLOT

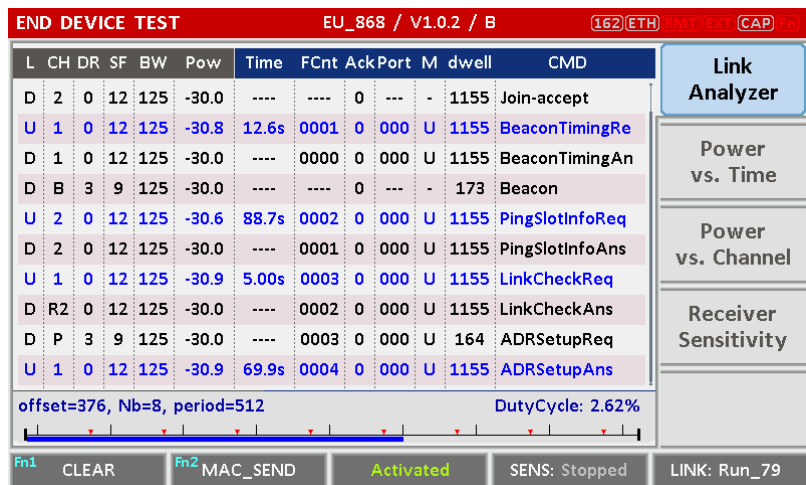

Fig 3.17 MAC command transmission through PING slot

5. [Send periodic Downlink message through PING slot]

Press **PARAM** key to open the parameter configuration screen and move to LINK tap. Select PERIODIC_DOWNLINK as CONFIRMED_DOWN or UNCONFIRMED_DOWN to transmit downlink message periodically.

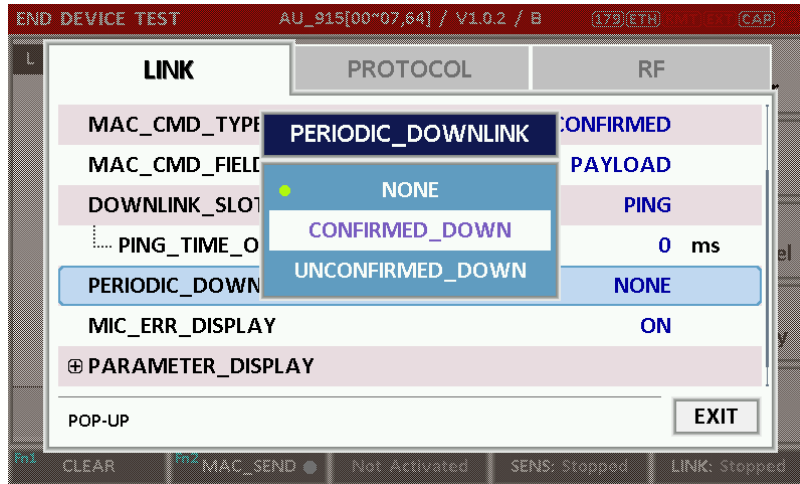

Fig 3.18 Selection of Periodic downlink mode in Parameter Configuration

3.9 Parameter Configuration and Basic Setup for GWT

3.9.1 Overview

To create a link with a Gateway and measure its performances, various protocol parameters as well as RF parameters should be configured in advance for users' purposes. This configuration is done in the parameter configuration screen as the following figure. Refer to 3.9.2 and 3.9.3 for descriptions of parameters.

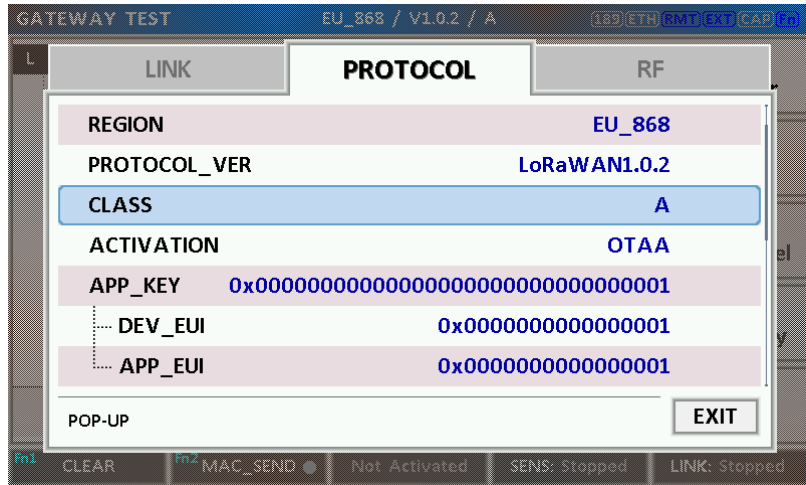

Fig 3.19 GWT Parameter Configuration Screen - PROTOCOL



Fig 3.20 GWT Parameter Configuration Screen - RF

3.9.2 PROTOCOL Parameters

REGION

RWC5020A supports various regions [EU 868, EU 433, US 915, AU 915, CN 470, KR 920, AS 923, IN 865]. Using this parameter, user could select the region to test.

PROTOCOL_VER

This parameter defines the version of LoRaWAN protocol to be emulated by RWC5020A.

CLASS

There are three different classes in LoRa device. Class A is Bi-directional End Devices, Class B is Bi-directional End Devices with scheduled receive slots, and Class C is Bi-directional End Devices with maximal receive slots. This parameter defines the class mode of RWC5020A.

ACTIVATION

LoRaWAN defines two types of Activation procedures (OTAA, ABP). This parameter defines the activation mode of RWC5020A.

APP_KEY

The APP_KEY is an AES-128 root key specific to the End Device. Whenever an End Device joins a network via over-the-air activation, the APP_KEY is used to derive the session keys NwksKey and AppSKey specific for that End Device to encrypt and verify network communication and application data. This parameter must be set to the same value as the APP_KEY on DUT.

DEV_EUI

The DEV_EUI is a globally unique End Device identifier. The DEV_EUI is stored in the End Device before the activation procedure is executed. If the CHECK_EUI is ON, this parameter must be set as the same value stored on the DUT.

APP_EUI

The APP_EUI is a global application ID in IEEE EUI64 address space that uniquely identifies the entity able to process the Join-request frame. The APP_EUI is stored in the End Device before the activation procedure is executed. If the CHECK_EUI is ON, this parameter must be set as the same value stored on the DUT.

NET_ID

The NET_ID is a network identifier to uniquely identify the network.

DEV_ADDR

During the activation, the gateway assigns DEV_ADDR value to the End Device. If activation mode is ABP, this parameter must be set as the same value stored on the DUT.

APPS_KEY

APPS_KEY is used to encrypt and verify application data between Gateway and End Device. This value is derived from APP_KEY during OTAA. If activation mode is ABP, this parameter must be set as the same value stored on the DUT.

NWKS_KEY

NWKS_KEY is used to encrypt and verify network data between Gateway and End Device. This value is derived from APP_KEY during OTAA. If activation mode is ABP, this parameter must be set as the same value stored on the DUT.

UPDATE_FCNT

This parameter determines the initial value of FCNT before activation procedure and also updates FCNT values after activation.

ADR

LoRa network allows the End Devices to individually use any of the possible data rates. This feature is used by the LoRaWAN to adapt and optimize the data rate of static End Devices. This is referred to as Adaptive Data Rate (ADR) and when this is enabled the network will be optimized to use the fastest data rate possible.

DOWNLINK_SLOT

When RWC5020A emulates End Device mode (GWT), it could receive a downlink frame through RX1 channel and/or RX2 channel. Using this parameter, users can select RX channel for testing the DUT.

UPLINK_DR

This parameter defines the data rate of uplink channel.

BATTERY

This parameter defines the battery level to be reported by *DevStatusAns* command.

SNR_MARGIN

This parameter defines the demodulation SNR ratio in dB rounded to the nearest integer value for

the last successfully received *DevStatusReq* command to be reported by *DevStatusAns* command.

NETWORK

This parameter indicates the type of LoRa network, in other words the synchronization word to be used in LoRa modulation.

3.9.3 RF Parameters

TX POW

This parameter defines the output power of RWC5020A in dBm.

PATH LOSS

User can set the path loss between RF port of RWC5020A and DUT RF port. RWC5020A's real output power will be increased by this value to compensate path loss.

FREQ OFFSET

This parameter defines the frequency offset value in ppm.

CH_MASK_0

This parameter defines the mask of channels to be used for LoRa communication, which is applicable only to EU 868, EU 433, KR 920, AS 923, and IN 865.

CH_MASK_0 ~ CH_MASK_4

These parameters define the masks of channel groups to be used for LoRa communication, which are applicable only to US 915 and AU 915, and CH_MASK_0 is the mask for the lowest channels.

CH_MASK_0 ~ CH_MASK_5

These parameters define the masks of channel groups to be used for LoRa communication, which are applicable only to CN 470, and CH_MASK_0 is the mask for the lowest channels.

RX2_FREQ

This parameter defines the frequency of a downlink using the second receive window (read only).

RX2 DR

This parameter defines the data rate of a downlink using the second receive window (read only).

DL CH 00 ~ DL CH xx

This parameter defines real channel frequency of each downlink channel index (read only). The maximum index depends on the REGION parameter.

UL CH 00 ~ UL CH xx

This parameter defines real channel frequency of each uplink channel index (read only). The maximum index depends on the REGION parameter.

ADR POW CTRL

This parameter defines whether to control the output power of RWC5020A with the LinkADRReq command.

3.10 Activation Procedure for GWT

3.10.1 Overview

RWC5020A supports both ways of activation of an End Device; Over The Air Activation (OTAA) and Activation By Personalization (ABP). This section describes how to configure parameters for OTAA and ABP respectively.

3.10.2 OTAA Procedure

1. [Parameter Window]

Press **PARAM** key to open the parameter configuration screen and select PROTOCOL tap to configure MAC protocol parameters.
2. [Region]

Set REGION parameter as needed.
3. [Protocol Version]

Set PROTOCOL_VER to LoRaWAN1.0 or LoRaWAN1.1.
4. [Activation Parameters]

LoRaWAN V1.0,

 - 1) Set ACTIVATION parameter to OTAA.
 - 2) Set APP_KEY to the application key specific to an End Device (RWC5020A), which shall be registered into the Network Server.
 - 3) Set DEV_EUI and APP_EUI parameters to values specific to an End Device (RWC5020A), which shall be registered into the Network Server.

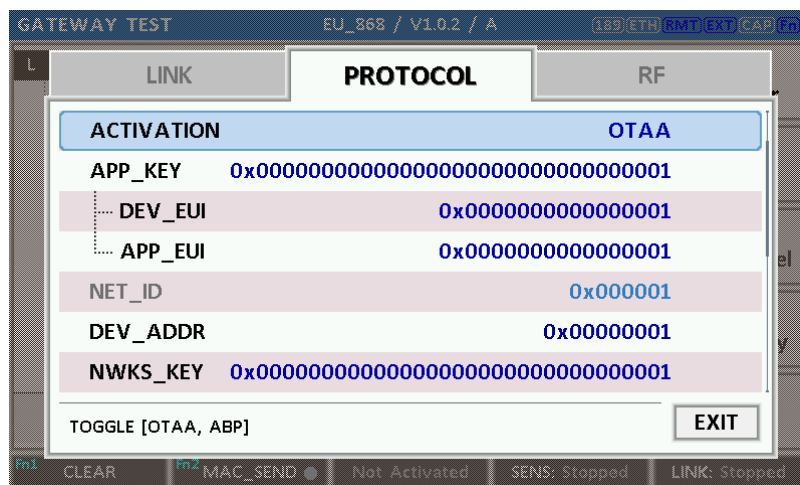

Fig 3.21 Parameters for OTAA (LoRaWAN V1.0)

LoRaWAN V1.1,

- 1) Set ACTIVATION parameter to OTAA.
- 2) Set NWK_KEY and APP_KEY parameters specific to an End Device (RWC5020A), which shall be registered into the Network Server.
- 3) Set DEV_EUI and JOIN_EUI parameters to values specific to an End Device (RWC5020A), which shall be registered into the Network Server.

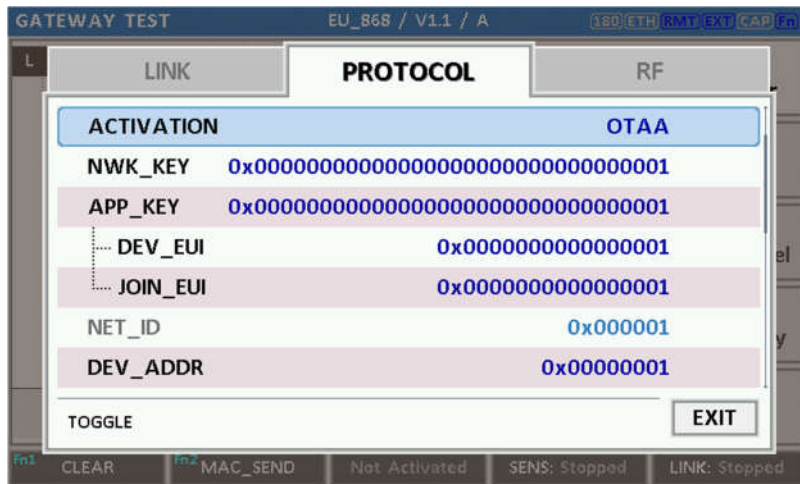

Fig 3.22 Parameters for OTAA (LoRaWAN V1.1)

5. [Downlink Slot]

Set DOWNLINK_SLOT parameter to RX1, RX2, or RX1&RX2 to determine a physical channel to be used for reception by RWC5020A (End Device). It can be configured according to test purposes.

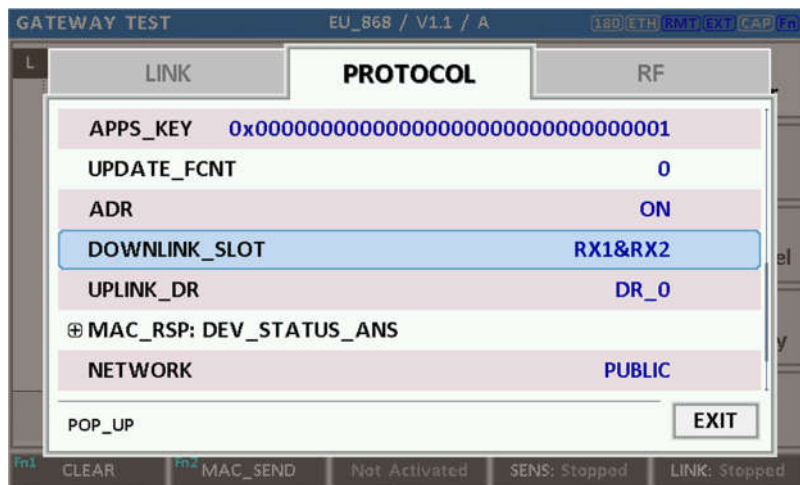

Fig 3.23 Selection of Downlink Slot

6. [RF Parameters Setup]

Select RF tap to configure RF parameters.

- 1) Set TX_POW and PATH_LOSS parameters if needed.
- 2) Expand CHANNEL_INFO to configure channel information. And set UPLINK_DR if necessary.



Fig 3.24 Channel Information in RF Parameters

3.10.3 ABP Procedure

1. [Parameter Window]

Press **PARAM** key to open the parameter configuration screen and select PROTOCOL tap to configure MAC protocol parameters.

2. [Region]

Set REGION parameter as needed.

3. [Protocol Version]

Set PROTOCOL_VER to LoRaWAN1.0 or LoRaWAN1.1

4. [Activation Parameters].

For LoRaWAN V1.0,

- 1) Set ACTIVATION parameter to ABP.
- 2) Set DEV_ADDR to a value specific to an End Device.
- 3) Set NWKS_KEY and APPS_KEY parameters to the two session keys unique to an End Device.

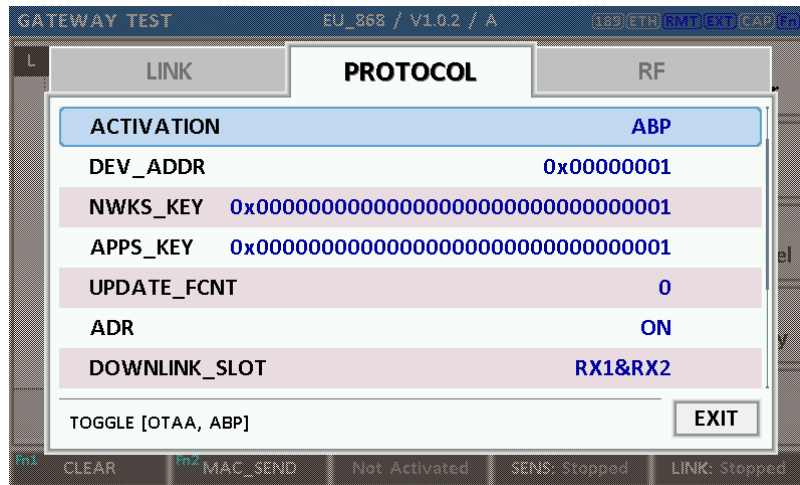

Fig 3.25 Parameters for ABP (LoRaWAN V1.0)

For LoRaWAN V1.1,

- 1) Set ACTIVATION parameter to ABP.
- 2) Set DEV_ADDR to a value specific to an End Device.
- 3) Set FNWKS_IKEY, SNWKS_IKEY, NWKS_EKEY and APPS_KEY parameters to the four session keys unique to an End Device.

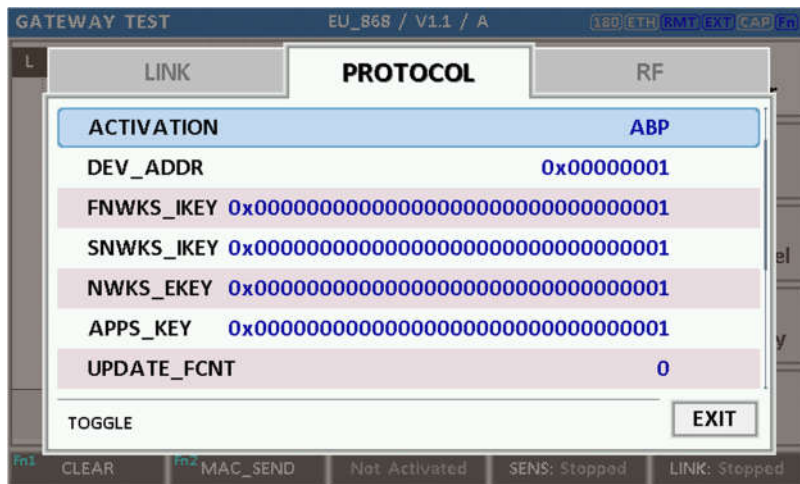

Fig 3.26 Parameters for ABP (LoRaWAN V1.1)

5. [RF Parameters Setup]

Refer to 3.10.2 for RF setup.

3.11 Usage of Link Analyzer for GWT

3.11.1 Overview

RWC5020A provides a function of Link Analyzer for EDT and GWT. In GWT, Link Analyzer helps to create a link between RWC5020A and a Gateway Under Test and to analyze the protocol messages.

3.11.2 Test Procedure

1. [Main Menu selection]
Set the Main Menu to GWT referring to 2.3.1.
2. [Sub Menu selection]
Set the Sub Menu to Link Analyzer referring to 2.3.2.
3. [Parameter configuration]
Press **PARAM** key to open the parameter configuration screen. Configure protocol parameters or RF parameters for users' purposes in PROTOCOL tap or RF tap respectively. Refer to 3.9 and 3.10 for details.
4. [DUT connection setup]
Connect the RF port of RWC5020A to the RF port of DUT with an RF cable for conduction test. For radiation test, use a special test environment, e.g., a shield box or an antenna. In the latter case, it is recommended to use a test jig for DUT positioning to guarantee the reliability and repeatability of test and measurement results.
5. [Execution]
Press **RUN** key, and RWC5020A will send a message to the DUT. As soon as communication starts, link messages between DUT and RWC5020A will be displayed in real time. On the right bottom side of the screen the link status is displayed as 'LINK: Running' or 'LINK: Stopped'. Refer to 2.5.4 for descriptions of the Link Analyzer screen.
6. [Analysis and utilization]
Pressing **←** or **→** key moves the cursor location to the link message window. Rotating the rotary knob shows the raw data of the current cursor position at the bottom of the screen in hexadecimal format. Rotating the rotary knob with **Fn** key pressed scrolls the screen by page-up or page-down. Pressing **←** or **→** key with **Fn** key pressed scrolls the screen in horizontal direction.
7. [Switch to other Sub Menu]
While the link status is running, switching to other Sub Menu is available. All data in Link Analyzer,

Power vs. Time, and Power vs. Channel are synchronized each other, since RWC5020A analyzes protocol messages and also measures RF power in processing the received frames.

3.11.3 Parameters

RWC5020A provides a function of sending a MAC command to DUT, defined in the LoRaWAN Specification, at the time users want. All parameters for each MAC command are configurable. Refer to 3.14 for details.

MAC CMD TYPE

This parameter defines the type of MAC command to be transmitted: confirmed or unconfirmed.

MAC CMD FIELD

This parameter defines the type of field where MAC command is stored in a frame: payload or option field.

INSTANT MAC CMD

This parameter defines which MAC command will be transmitted.

INSTANT MAC CMD: LINK CHECK

This parameter is for sending *LinkCheckReq* command to DUT, which expects *LinkCheckAns* command from it. *LinkCheckReq* command may be used to validate connectivity with the network.

INSTANT MAC CMD: DEVICE TIME

This parameter is for sending *DeviceTimeReq* command to DUT, which expects *DeviceTimeAns* command from it. *DeviceTimeReq* command requests the current network date and time from the network.

INSTANT MAC CMD: DEVICE MODE

This parameter is for sending *DeviceModeInd* command to DUT, which expects *DeviceModeConf* command from it. With *DeviceModeInd* command, RWC5020A indicates to the network that it wants to operate either in class A or C.

INSTANT MAC CMD: RESET IND

This parameter is for sending *ResetInd* command to DUT, which expects *ResetConf* command from

it. With *ResetInd* command, RWC5020A indicates to the network that it has been re-initialized and that it has switched back to its default MAC & radio parameters (i.e. the parameters originally programmed into the device at fabrication except for the three frame counters). This MAC command is only available to ABP devices activated on a LoRaWAN1.1 compatible Network Server.

PERIODIC UPLINK

This parameter defines the periodic uplink of RWC5020A after the activation procedure finishes. The type of periodic uplink can be LINK_CHECK_REQ, CONFIRMED_UP, UNCONFIRMED_UP, or DL_COUNTER.

PAYLOAD TYPE

If it is set as '0000_0000', the frame payload will be set all zero bytes. If it is set as '1111_1111', the frame payload will be set all one bytes. If it is set as '1111_0000', frame payload will be set 0xF0 bytes. If it is set as '1010_1010', frame payload will be set 0xAA bytes. If it is set as PRBS, frame payload will be set pseudo random bytes. If it is set as 'USER', frame payload will be set as PAYLOAD parameter values.

INTERVAL

This parameter defines the time interval of the periodic uplink.

FPORT

This parameter defines the FPort number of a user-defined MAC Command.

PAYLOAD SIZE

This parameter defines the size of payload of a user-defined MAC Command.

PAYLOAD





This parameter defines the content of payload in hexadecimal format and appears only when PAYLOAD_TYPE is 'USER'.

3.12 Usage of Power vs. Time for GWT

3.12.1 Overview

RWC5020A provides a function of Power vs. Time measurement for EDT and GWT. In GWT, Power vs. Time measurement helps to create a link between RWC5020A and a Gateway Under Test and to measure the received power with respect to data rates.

3.12.2 Test Procedure

1. [Main Menu selection]
Set the Main Menu to GWT referring to 2.3.1.
2. [Sub Menu selection]
Set the Sub Menu to Power vs. Time referring to 2.3.2.
3. [Parameter configuration]
Press  key to open the parameter configuration screen. Configure protocol parameters or RF parameters for users' purposes in PROTOCOL tap or RF tap respectively. Refer to 3.9 and 3.10 for details.
4. [DUT connection setup]
Connect the RF port of RWC5020A to the RF port of DUT with an RF cable for conduction test. For radiation test, use a special test environment, e.g., a shield box or an antenna. In the latter case, it is recommended to use a test jig for DUT positioning to guarantee the reliability and repeatability of test and measurement results.
5. [Execution]
Press  key, and RWC5020A will send a message to the DUT. As soon as communication starts, the measured power will be displayed on the screen in real time. On the right bottom side of the screen the link status is displayed as 'LINK: Running' or 'LINK: Stopped'. Refer to 2.5.5 for descriptions of the Power vs. Time screen.
6. [Analysis and utilization]
Pressing  or  key moves the cursor location to the measurement window, and the cursor changes to the marker. Rotating the rotary knob shows all measured values of the current marker position at the top of the screen.
7. [Switch to other Sub Menu]
While the link status is running, switching to other Sub Menu is available. All data in Link Analyzer, Power vs. Time, and Power vs. Channel are synchronized each other, since RWC5020A analyzes

protocol messages and also measures RF power in processing the received frames.

3.12.3 Parameters

SCALE

It determines scaling of Y-axis. AUTO scales automatically for each measurement and MANUAL keeps the current scaling according to MAX_Y and MIN_Y values.

MAX_Y

In case of MANUAL scaling, the maximum value of Y-axis can be set.

MIN_Y

In case of MANUAL scaling, the minimum value of Y-axis can be set.

3.13 Usage of Power vs. Channel for GWT

3.13.1 Overview

RWC5020A provides a function of Power vs. Channel measurement for EDT and GWT. In GWT, Power vs. Channel measurement helps to create a link between RWC5020A and a Gateway Under Test and to measure the received power with respect to RF channels.

3.13.2 Test Procedure

1. [Main Menu selection]
Set the Main Menu to GWT referring to 2.3.1.
2. [Sub Menu selection]
Set the Sub Menu to Power vs. Channel referring to 2.3.2.
3. [Parameter configuration]
Press **PARAM** key to open the parameter configuration screen. Configure protocol parameters or RF parameters for users' purposes in PROTOCOL tap or RF tap respectively. Refer to 3.9 and 3.10 for details.
4. [DUT connection setup]
Connect the RF port of RWC5020A to the RF port of DUT with an RF cable for conduction test. For radiation test, use a special test environment, e.g., a shield box or an antenna. In the latter case, it is recommended to use a test jig for DUT positioning to guarantee the reliability and repeatability of test and measurement results.
5. [Execution]
Press **RUN** key, and RWC5020A will send a message to the DUT. As soon as communication starts, the measured power will be displayed on the screen in real time. On the right bottom side of the screen the link status is displayed as 'LINK: Running' or 'LINK: Stopped'. Refer to 2.5.6 for descriptions of the Power vs. Channel screen.
6. [Switch to other Sub Menu]
While the link status is running, switching to other Sub Menu is available. All data in Link Analyzer, Power vs. Time, and Power vs. Channel are synchronized each other, since RWC5020A analyzes protocol messages and also measures RF power in processing the received frames.

3.13.3 Parameters

SCALE

It determines scaling of Y-axis. AUTO scales automatically for each measurement and MANUAL keeps the current scaling according to MAX_Y and MIN_Y values.

MAX_Y

In case of MANUAL scaling, the maximum value of Y-axis can be set.

MIN_Y





In case of MANUAL scaling, the minimum value of Y-axis can be set.

3.14 Usage of Receiver Sensitivity for GWT

3.14.1 Overview

Receiver Sensitivity is a function of testing the receiver performance of DUT. RWC5020A sweeps its power level from the start value to the stop value with the step value and checks whether DUT functions properly, and stops immediately after DUT does not function properly.

3.14.2 Test Procedure

1. [Main Menu selection]
Set the Main Menu to GWT referring to 2.3.1.
2. [Sub Menu selection]
Set the Sub Menu to Receiver Sensitivity referring to 2.3.2.
3. [Parameter configuration]
Press  key to open the parameter configuration screen. Configure protocol parameters or RF parameters for users' purposes in PROTOCOL tap or RF tap respectively. Refer to 3.9 and 3.10 for details. In SENSITIVITY tap, all parameters can be configured to be used in the execution of sensitivity test.
4. [DUT connection setup]
Connect the RF port of RWC5020A to the RF port of DUT with an RF cable for conduction test. For radiation test, use a special test environment, e.g., a shield box or an antenna. In the latter case, it is recommended to use a test jig for DUT positioning to guarantee the reliability and repeatability of test and measurement results.
5. [Execution]
Press  key, and RWC5020A will send a message for activation to the DUT. As soon as the activation procedure finishes, RWC5020A starts the sensitivity test from the start power value, checks whether DUT functions properly at each power step value, stops immediately after DUT does not function properly, and shows the final results. On the right bottom side of the screen the sensitivity status is displayed as 'SENS: Running' or 'SENS: Stopped' as well as the link status. Refer to 2.5.7 for descriptions of the Receiver Sensitivity screen.
6. [Analysis and utilization]
Pressing  or  key moves the cursor location to the sensitivity window, and the cursor changes to the marker. Rotating the rotary knob shows all measured values of the current marker position at the top of the screen.

7. [Switch to other Sub Menu]

While the sensitivity status is running, switching to other Sub Menu is available. All data in Link Analyzer, Power vs. Time, and Power vs. Channel are synchronized each other, since RWC5020A analyzes protocol messages and also measures RF power in processing the received frames.

3.14.3 Parameters

PACKET_NUM

This is the packet number of tests at each test point. Increasing it the test result may have higher resolution but the testing time may become longer.

START_POW

This defines the start value of POWER sweep in POWER mode.

STOP_POW

This defines the stop value for POWER sweep in POWER mode (read only).

STEP_POW

This defines the step value for POWER sweep in POWER mode.

NUM_POW

This defines the number of power values for POWER sweep.

SET_SF_AT_START

This is a parameter to determine whether to set Uplink DR before Sensitivity Test starts.

SF

This is a parameter a SF value to set Uplink DR only when SET_SF_AT_START is YES.

TARGET_PER

This is a parameter to set user's target PER. In POWER mode, the test sweeps fully in the range of POWER until DUT does not satisfy TARGET_PER.

3.15 Transmission of MAC Commands for GWT

3.15.1 Overview

After the activation procedure is completed successfully, RWC5020A can send any MAC command to DUT as defined on Parameter configuration.

3.15.2 Test Procedure

1. [Activation]

Follow the steps referring to 3.11 to complete the activation successfully.

2. [MAC command selection]

Press **PARAM** key to open the parameter configuration screen and move to LINK tap. Select a MAC command to be sent from the list of INSTANT_MAC_CMD and configure its parameters. Refer to 3.10.3 for details about MAC commands. Close the parameter configuration screen.

3. [MAC command transmission]

Press **Fn** + **2 B** key to select 'MAC_SEND' button on the bottom of the screen. Then RWC5020A will send the MAC command to DUT at the next uplink channel.

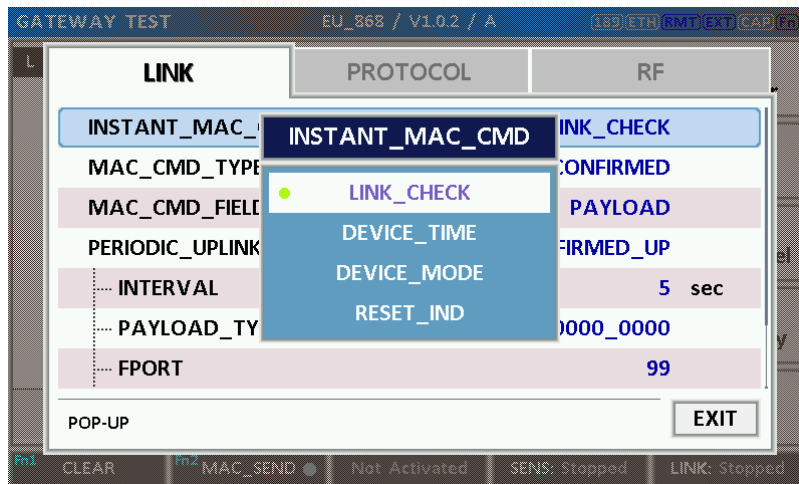

Fig 3.27 Example of MAC command selection

GATEWAY TEST												EU_868 / V1.0.2 / A			189 ETH RMT EXT CAP Fn		
L	CH	DR	SF	BW	Pow	Time	FCnt	AckPort	M	dwell	CMD	Link Analyzer					
U	1	0	12	125	-30.0	REF	----	0	---	-	1482	Join-request	<div style="border: 1px solid gray; padding: 2px; margin-bottom: 2px;">Power vs. Time</div> <div style="border: 1px solid gray; padding: 2px; margin-bottom: 2px;">Power vs. Channel</div> <div style="border: 1px solid gray; padding: 2px; margin-bottom: 2px;">Receiver Sensitivity</div>				
D	1	0	12	125	-35.9	----	----	0	---	-	1155	Join-accept					
U	2	0	12	125	-30.0	12.9s	0000	0	099	U	1646	DataUp					
D	2	0	12	125	-31.6	----	0000	0	224	U	1155	Activate_TM					
U	0	0	12	125	-30.0	5.00s	0001	0	224	U	1155	DownlinkCounte					
U	1	0	12	125	-30.0	5.21s	0002	0	000	U	1155	LinkCheckReq					
D	1	0	12	125	-31.6	----	0001	0	000	U	1155	LinkCheckAns					
U	2	0	12	125	-30.0	5.00s	0003	0	224	U	1155	DownlinkCounte					
U	2	0	12	125	-30.0	5.21s	0004	0	224	U	1155	DownlinkCounte					
U	2	0	12	125	-30.0	5.20s	0005	0	224	U	1155	DownlinkCounte					
Margin=20, GwCnt=1																	
60 01 00 00 00 80 01 00 00 02 14 01 5A 19 F1 86																	
Fn1 CLEAR		Fn2 MAC_SEND		Not Activated		SENS: Stopped		LINK: Stopped									

Fig 3.28 Example a single MAC command transmission (Fn + 2 B)

3.16 Usage of Link Analyzer for Class B GWT

3.16.1 Overview

This section shows how to connect Class B Gateway and configure related parameters.

3.16.2 Test Procedure

1. [Parameter Configuration]

Press **PARAM** key to open the parameter configuration screen and move to PROTOCOL tap. Select CLASS as B and configure parameters such as PING_PERIODICITY and PING_DR.
2. [Activation]

Refer to 3.10 to configure parameters for activation.
3. [Execution]

Press **RUN** key, and RWC5020A will be starting activation. As soon as the activation procedure finishes, RWC5020A sends *DeviceTimeReq* command to DUT. The following figure is an example of communication between Class B Gateway and RWC5020A, showing related MAC commands and Class B flag.
4. [MAC command transmission]

Refer to 3.16 for details of MAC command transmission, which is also applicable to Class B.

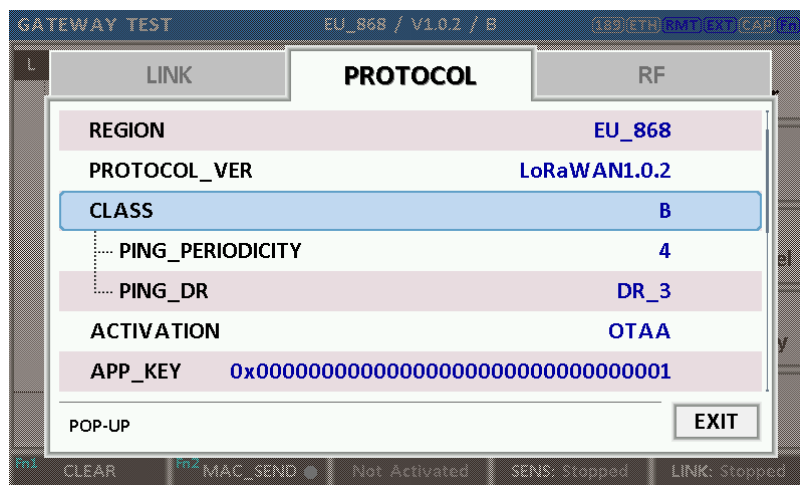

Fig 3.29 Selection of Class B in Parameter Configuration

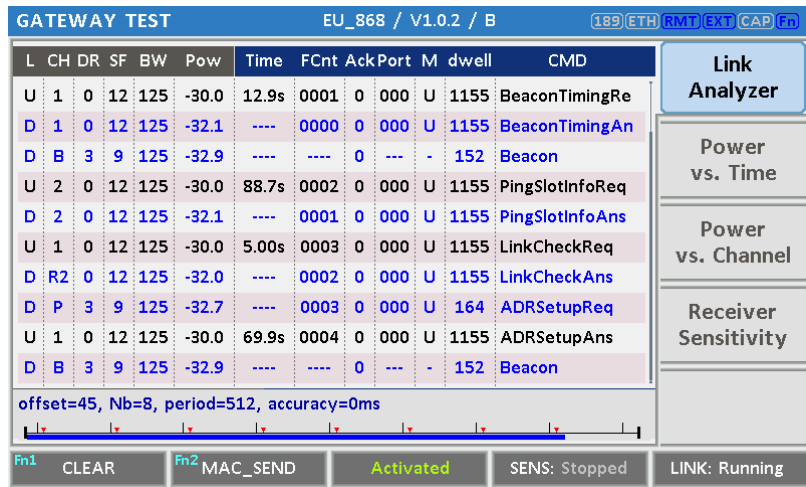

Fig 3.30 Example of communication with Class B Gateway

3.17 Usage of Signal Generator for NST

3.17.1 Overview

Signal Generator is a function of transmitting the defined test waveform to DUT repeatedly. Two different modes are provided; LoRa and CW. Especially in case of LoRa mode, various parameters are configurable to compose a LoRa test frame.

3.17.2 Test Procedure

1. [Main Menu selection]
Set the Main Menu to NST referring to 2.3.1.
2. [Sub Menu selection]
Set the Sub Menu to Signal Generator referring to 2.3.2.
3. [Parameter configuration]
Press **PARAM** key to open the parameter configuration screen. Configure parameters for users' purposes in NST_TX tap.
4. [DUT connection setup]
Connect the RF port of RWC5020A to the RF port of DUT with an RF cable for conduction test. For radiation test, use a special test environment, e.g., a shield box or an antenna. In the latter case, it is recommended to use a test jig for DUT positioning to guarantee the reliability and repeatability of test and measurement results.
5. [Execution]
Press **RUN** key, and RWC5020A will start transmission of a test waveform to the DUT. If REPEAT_NUM is set to zero, the test waveform will be transmitted infinitely. Otherwise, RWC5020A will stop automatically right after the number of transmission reaches the REPEAT_NUM value.

3.17.3 NST_TX Parameters

MODULATION

This parameter defines the modulation type of Signal Generator; LoRa, FSK or CW.

DUT_TYPE

This parameter defines the DUT type of Signal Generator; End_device, Gateway, Unknow. TX signal polarity and CR value will be set automatically depends on DUT type.

NETWORK

This parameter indicates the type of LoRa network (synchronization word) to be used in LoRa modulation.

BW

This parameter defines the bandwidth of a LoRa test frame.

SF

This parameter defines the spreading factor of a LoRa test frame.

CR

This parameter defines the coding rate of a LoRa test frame, which is applicable only when DUT_TYPE is 'GATEWAY'.

PREAMBLE_SIZE

This parameter defines the preamble size of a LoRa test frame.

FM_DEVIATION

This parameter defines the FM deviation value for FSK modulation.

DATA_RATE

This parameter defines the data rate value for FSK modulation.

SYNC_WORD_SIZE

This parameter defines the Sync word size for FSK modulation

SYNC_WORD

This parameter defines the Sync word for FSK modulation

TX POLARITY

This parameter defines the TX signal polarity.

REPEAT_NUM

This parameter defines the number of transmission of a LoRa test frame.

INTERVAL

This parameter defines the time interval between consecutive LoRa test frames.

3.17.4 PROTOCOL Parameters

DUT_TYPE

This parameter defines the type of DUT; END_DEVICE or GATEWAY, which determines whether the frame is for uplink or downlink.

MAC_FORMAT

This parameter defines whether to use MAC parameters in LoRa test frame.

PAYLOAD_TYPE

This parameter defines the type of payload of LoRa test frame.

PAYLOAD_SIZE

This parameter defines the size of payload of LoRa test frame.

PAYLOAD

This parameter defines the content of payload in hexadecimal format and appears only when PAYLOAD_TYPE is 'USER'.

DEV_ADDR

This parameter defines the device address field in LoRa test frame and appears only when MAC_FORMAT is 'ON'.

NWKS_KEY

This parameter defines the network session key field in LoRa test frame and appears only when MAC_FORMAT is 'ON'.

APPS_KEY

This parameter defines the application session key field in LoRa test frame and appears only when MAC_FORMAT is 'ON'.

FCNT

This parameter defines the frame count field in LoRa test frame and appears only when MAC_FORMAT is 'ON'.

FCNT_MODE

This parameter defines the mode of FCnt operation; FIXED or INCREASING.

ADR

This parameter defines the ADR field in LoRa test frame and appears only when MAC_FORMAT is 'ON'.

ACK

This parameter defines the ACK field in LoRa test frame and appears only when MAC_FORMAT is 'ON'.

ADR_ACK_REQ

This parameter defines the ADRACKReq field in LoRa test frame and appears only when MAC_FORMAT is 'ON' and DUT_TYPE is 'GATEWAY'.

FPENDING

This parameter defines the FPending field in LoRa test frame and appears only when MAC_FORMAT is 'ON' and DUT_TYPE is 'END_DEVICE'.

3.17.5 RF Parameters

TX POW

This parameter defines the output power of RWC5020A in dBm.

PATH LOSS

User can set the path loss between RF port of RWC5020A and DUT RF port. RWC5020A's real output power will be increased by this value to compensate path loss.

FREQ

This parameter defines the frequency of RWC5020A.



Fig 3.31 NST_TX Parameters for Signal Generator

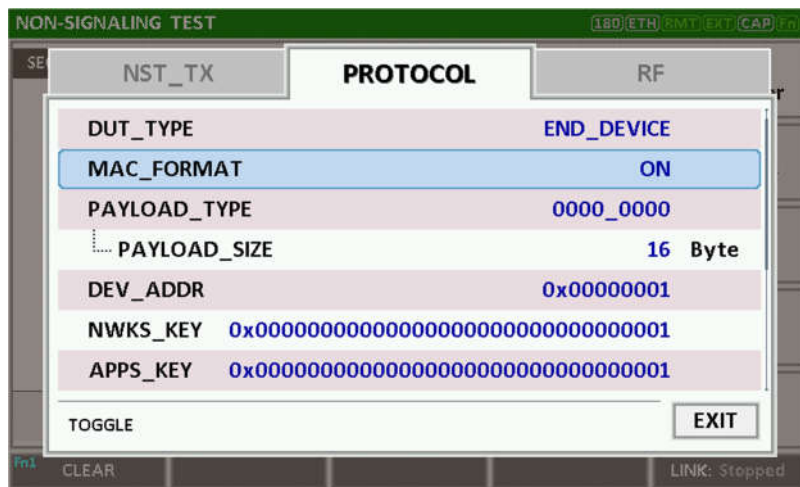

Fig 3.32 PROTOCOL Parameters 1/2 for Signal Generator



Fig 3.33 PROTOCOL Parameters 2/2 for Signal Generator

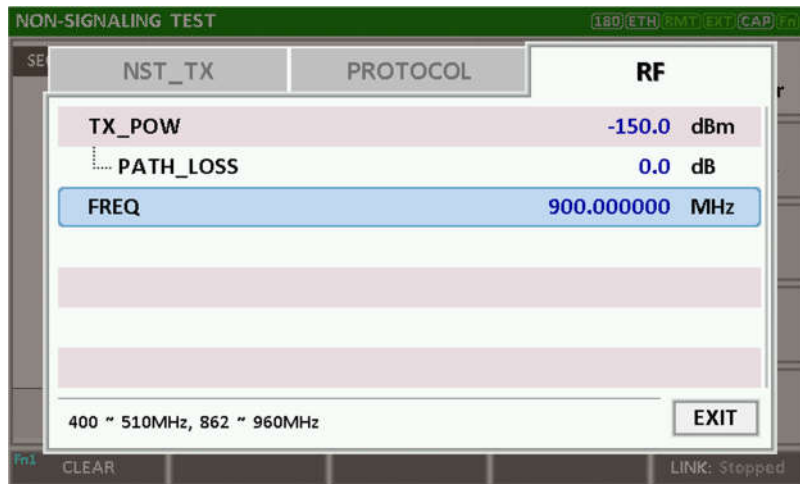

Fig 3.34 RF Parameters for Signal Generator

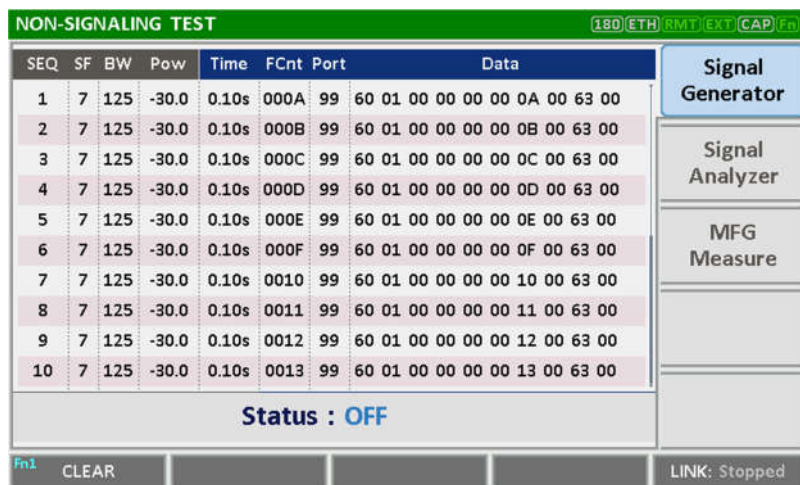



Fig 3.35 Signal Generator screen

3.18 Usage of Signal Analyzer for NST

3.18.1 Overview

Signal Analyzer is a function of analyzing LoRa frames received from DUT repeatedly. Various parameters are configurable to receive a LoRa test frame.

3.18.2 Test Procedure

1. [Main Menu selection]
Set the Main Menu to NST referring to 2.3.1.
2. [Sub Menu selection]
Set the Sub Menu to Signal Analyzer referring to 2.3.2.
3. [Parameter configuration]
Press  key to open the parameter configuration screen. Configure parameters for users' purposes in NST_RX tap.
4. [DUT connection setup]
Connect the RF port of RWC5020A to the RF port of DUT with an RF cable for conduction test. For radiation test, use a special test environment, e.g., a shield box or an antenna. In the latter case, it is recommended to use a test jig for DUT positioning to guarantee the reliability and repeatability of test and measurement results.
5. [Execution]
Press  key, and RWC5020A will start measurement of a test waveform from the DUT. RWC5020A will not only measure TX power of DUT but also count the number of received frames only when all parameters are matched with those of the received frames, e.g. Spreading Factor.

3.18.3 NST_RX Parameters

MODULATION

This parameter defines the modulation type of Signal Analyzer; LoRa, FSK or CW.

DUT_TYPE

This parameter defines the DUT type of Signal Analyzer; End_device, Gateway, Unknow. RX signal polarity and CR value will be set automatically depends on DUT type.

NETWORK

This parameter indicates the type of LoRa network (synchronization word) to be used in LoRa modulation.

BW

This parameter defines the bandwidth of a LoRa test frame to receive.

SF

This parameter defines the spreading factor of a LoRa test frame to receive. If this value is set as ANY, RWC5020A receives any kind of SF packets

DATA RATE

This parameter defines the data rate value for FSK modulation.

SYNC WORD SIZE

This parameter defines the Sync word size for FSK modulation

SYNC WORD

This parameter defines the Sync word for FSK modulation

RX POLARITY

This parameter defines the RX signal polarity.

3.18.4 PROTOCOL Parameters

DUT TYPE

This parameter defines the type of DUT; END_DEVICE or GATEWAY, which determines whether the frame is for uplink or downlink.

MAC FORMAT

This parameter defines whether to use MAC parameters in LoRa test frame to be analyzed.

NWKS_KEY

This parameter defines the network session key field in LoRa test frame to be analyzed and appears only when MAC_FORMAT is 'ON'.

APPS_KEY

This parameter defines the application session key field in LoRa test frame to be analyzed and appears only when MAC_FORMAT is 'ON'.

3.18.5 RF Parameters

PATH_LOSS

User can set the path loss between RF port of RWC5020A and DUT RF port. The measured power will be compensated with the defined path loss.

FREQ

This parameter defines the frequency of RWC5020A.



Fig 3.36 NST_RX Parameters for Signal Analyzer



Fig 3.37 PROTOCOL Parameters for Signal Analyzer

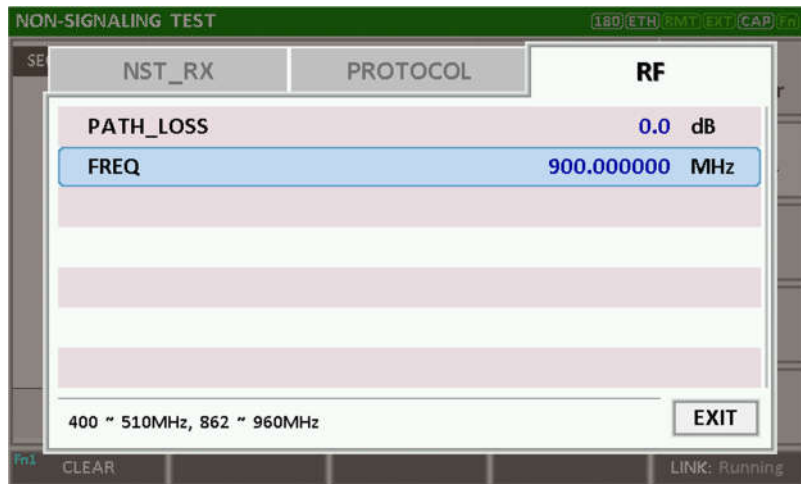
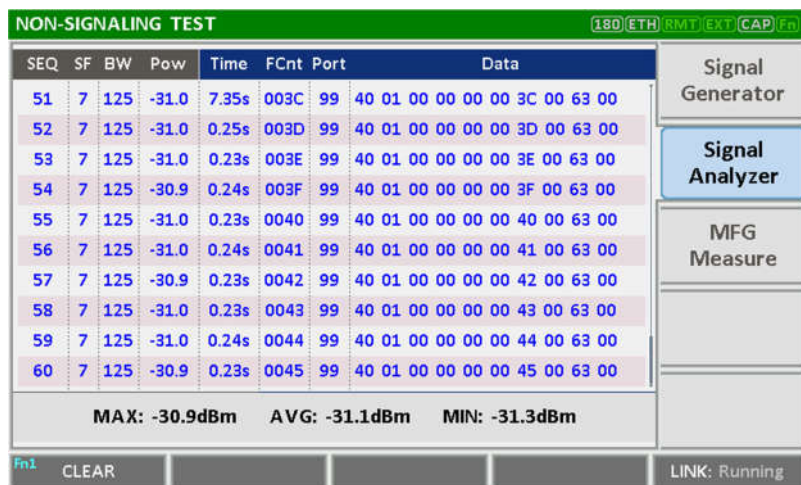

Fig 3.38 RF Parameters for Signal Analyzer



SEQ	SF	BW	Pow	Time	FCnt	Port	Data	
51	7	125	-31.0	7.35s	003C	99	40 01 00 00 00 00 3C 00 63 00	
52	7	125	-31.0	0.25s	003D	99	40 01 00 00 00 00 3D 00 63 00	
53	7	125	-31.0	0.23s	003E	99	40 01 00 00 00 00 3E 00 63 00	
54	7	125	-30.9	0.24s	003F	99	40 01 00 00 00 00 3F 00 63 00	
55	7	125	-31.0	0.23s	0040	99	40 01 00 00 00 00 40 00 63 00	
56	7	125	-31.0	0.24s	0041	99	40 01 00 00 00 00 41 00 63 00	
57	7	125	-30.9	0.23s	0042	99	40 01 00 00 00 00 42 00 63 00	
58	7	125	-31.0	0.23s	0043	99	40 01 00 00 00 00 43 00 63 00	
59	7	125	-31.0	0.24s	0044	99	40 01 00 00 00 00 44 00 63 00	
60	7	125	-30.9	0.23s	0045	99	40 01 00 00 00 00 45 00 63 00	
MAX: -30.9dBm							AVG: -31.1dBm	MIN: -31.3dBm

Fig 3.39 Signal Analyzer screen

3.19 Usage of MFG for NST

3.19.1 Overview

MFG is a function of testing TX and RX performances of DUT automatically in manufacturing lines. Various parameters are configurable as users' purposes.

3.19.2 Test Procedure

1. [Main Menu selection]
Set the Main Menu to NST referring to 2.3.1.
2. [Sub Menu selection]
Set the Sub Menu to MFG referring to 2.3.2.
3. [Parameter configuration]
Press **PARAM** key to open the parameter configuration screen. Configure parameters for users' purposes in NST_MFG tap.
4. [DUT connection setup]
Connect the RF port of RWC5020A to the RF port of DUT with an RF cable for conduction test. For radiation test, use a special test environment, e.g., a shield box or an antenna. In the latter case, it is recommended to use a test jig for DUT positioning to guarantee the reliability and repeatability of test and measurement results.
5. [Execution]
Press **RUN** key, and RWC5020A will wait until receiving a trigger signal from DUT, then start transmission of the test frame as many as pre-defined number of times. If done, the tester will wait until receiving the test report from DUT, which will include the number of frames it received successfully. RWC5020A will not only calculate PER but also measure TX power of DUT.

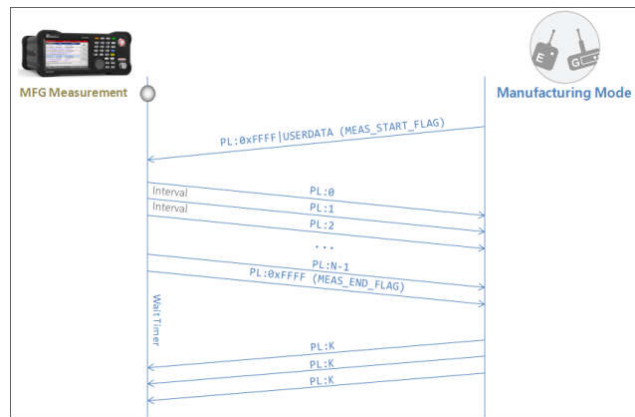

Fig 3.40 Test Scenario in MFG Test

3.19.3 NST_MFG Parameters

MODULATION

This parameter defines the modulation type of MFG test; LoRa, FSK or CW.

DUT_TYPE

This parameter defines the DUT type of MFG test; End_device, Gateway, Unknow. TX/RX signal polarity and CR value will be set automatically depends on DUT type.

NETWORK

This parameter indicates the type of LoRa network (synchronization word) to be used in LoRa modulation in MFG test.

BW

This parameter defines the bandwidth of a LoRa test frame to be used in MFG test.

SF

This parameter defines the spreading factor of a LoRa test frame to be used in MFG test. If this value is set as ANY, RWC5020A receives any kind of SF packets and apply this SF value for TX packets.

CR

This parameter defines the coding rate of a LoRa test frame to be used in MFG test, which is applicable only when DUT_TYPE is 'GATEWAY'.

PREAMBLE_SIZE

This parameter defines the preamble size of a LoRa test frame to be used in MFG test.

FM_DEVIATION

This parameter defines the FM deviation value for FSK modulation.

DATA_RATE

This parameter defines the data rate value for FSK modulation.

SYNC WORD SIZE

This parameter defines the Sync word size for FSK modulation

SYNC WORD

This parameter defines the Sync word for FSK modulation

TX POLARITY

This parameter defines the TX signal polarity.

RX POLARITY

This parameter defines the RX signal polarity.

REPEAT NUM

This parameter defines the number of transmission of a LoRa test frame to be used in MFG test.

INTERVAL

This parameter defines the time interval between consecutive LoRa test frames to be used in MFG test.

PER CRITERIA

This parameter defines the user's criteria of the result value of PER measurement in MFG test.

POW CRITERIA UPPER

This parameter defines the user's upper criteria of the result value of Power measurement in MFG test.

POW CRITERIA LOWER

This parameter defines the user's lower criteria of the result value of Power measurement in MFG test.

TIME_OUT

This parameter defines the timeout until RWC5020A waits for a LoRa frame from DUT.

3.19.4 PROTOCOL Parameters

DUT_TYPE

This parameter defines the type of DUT; END_DEVICE or GATEWAY, which determines whether the frame is for uplink or downlink in MFG test.

MAC_FORMAT

This parameter defines whether to use MAC parameters in LoRa test frame in MFG test.

PAYLOAD_TYPE

This parameter defines the type of payload of LoRa test frame in MFG test.

PAYLOAD_SIZE

This parameter defines the size of payload of LoRa test frame in MFG test.

PAYLOAD

This parameter defines the content of payload in hexadecimal format in MFG test and appears only when PAYLOAD_TYPE is 'USER'.

DEV_ADDR

This parameter defines the device address field in LoRa test frame in MFG test and appears only when MAC_FORMAT is 'ON'.

NWKS_KEY

This parameter defines the network session key field in LoRa test frame in MFG test and appears only when MAC_FORMAT is 'ON'.

APPS_KEY

This parameter defines the application session key field in LoRa test frame in MFG test and appears only when MAC_FORMAT is 'ON'.

FCNT

This parameter defines the frame count field in LoRa test frame in MFG test and appears only when MAC_FORMAT is 'ON'.

FCNT_MODE

This parameter defines the mode of FCnt operation in MFG test; FIXED or INCREASING.

ADR

This parameter defines the ADR field in LoRa test frame in MFG test and appears only when MAC_FORMAT is 'ON'.

ACK

This parameter defines the ACK field in LoRa test frame in MFG test and appears only when MAC_FORMAT is 'ON'.

ADR_ACK_REQ

This parameter defines the ADRACKReq field in LoRa test frame in MFG test and appears only when MAC_FORMAT is 'ON' and DUT_TYPE is 'GATEWAY'.

FPENDING

This parameter defines the FPending field in LoRa test frame in MFG test and appears only when MAC_FORMAT is 'ON' and DUT_TYPE is 'END_DEVICE'.

3.19.5 RF Parameters

TX POW

This parameter defines the output power of RWC5020A in dBm.

PATH LOSS

User can set the path loss between RF port of RWC5020A and DUT RF port. The measured power will be compensated with the defined path loss.

FREQ

This parameter defines the frequency of RWC5020A.



Fig 3.41 NST_MFG Parameters for MFG Test (1/2)



Fig 3.42 NST_MFG Parameters for MFG Test (2/2)



Fig 3.43 PROTOCOL Parameters for MFG Test

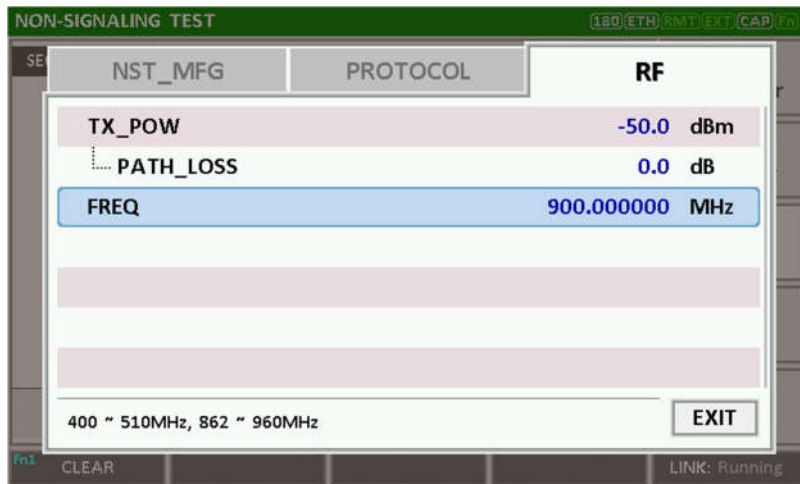

Fig 3.44 RF Parameters for MFG Test

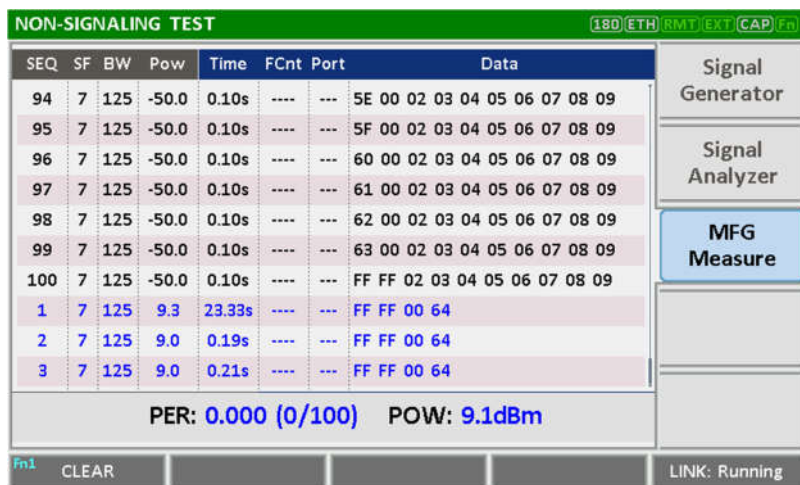

Fig 3.45 Example of MFG Test Completion

IV. Remote Control Programming

PC may control the RWC5020A remotely through Ethernet or RS232C interface using a comprehensive set of commands. This section provides the necessary information to operate the RWC5020A under Ethernet and RS232C control.

- 4.1 Introduction
- 4.2 RS-232C Interface
- 4.3 Ethernet Interface
- 4.4 Command List

4.1 Introduction

The RWC5020A supports RS232C and Ethernet Interface, located at the rear panel for remote operation under PC control. Ethernet is used for high speed and flexible interfaces. To use Ethernet, socket programming is required. RS232C is a slow serial interface, but it does not need any special devices, and is easy to use.

4.1.1 Command Structure

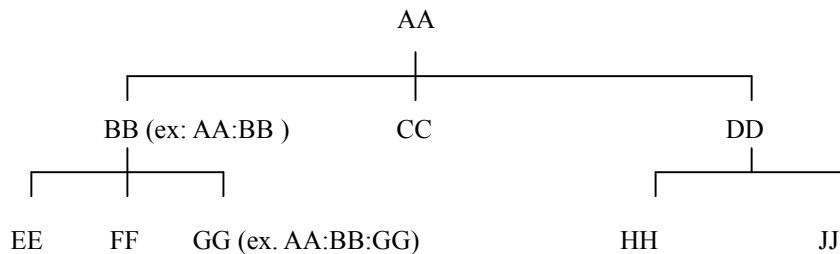

- You must follow a particular path to reach lower level subcommands. For example, if you wish to access the GG command, you must follow the path AA to BB to GG (AA:BB:GG)
- Commands consist of *set commands* and *query commands* (usually simply called commands and queries). Set commands change instrument settings or perform a specific action. Queries cause the RWC5020A to return data and information about its status. Most commands have both a set form and query form. The query form of the command is started with “READ” and the set form of the command is started with “CONF”.
- For example, one of the set commands is **CONF:RF:TX_POW -100.0** and one of the query commands is **READ:RF:TX_POW?**
- When a *colon* is placed between two command mnemonics, it moves the current path down one level in the command tree
- A *space* is used to separate parameters from commands. AA:BB:FF 20
- Some commands require two parameters. Refer to Command list.

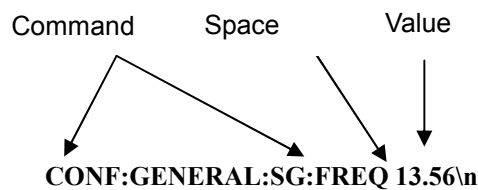

Note: All commands should be finished by LF (Line Feed, Char(10)) or semicolon(;).

4.1.2 Command Parameter Types

- Integer Parameter: CONF:RF:TX_POW <Value> <LF>
- Discrete Parameter: CONF:SYSTEM:REF_CLK {INT | EXT} <LF>

4.1.3 Response to Query

- Integer: Returns an integer value, e.g., 0, 100, 256, -230.
- Discrete: Returns selection

Command & Query	Response
READ:RF:TX_POW?	-100.0
READ:SYSTEM:REF_CLK?	EXT

Note: All responses are finished by LF (Line Feed, Char(10)).

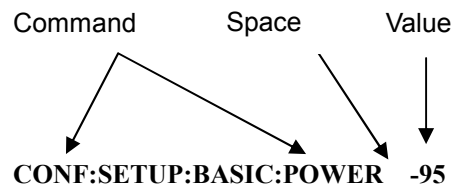

4.2 RS-232C Interface

4.2.1 Configuration

RS-232C Connection

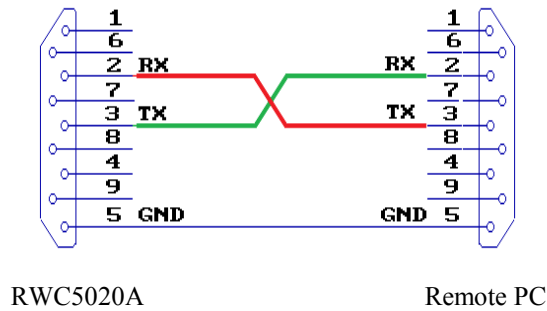

RS232C Parameter Setup

RS232C parameters of Remote PC should be set up as the following:

Parameter	Value	Description
DATA_RATE	115200	BPS
DATA BITS	8-bit	Length of Data Bit
PARITY	Off	Error Check Bit
STOP BIT	1-bit	Stop bit

4.2.2 Remote Programming Guide Using RS232C on a Windows System

Programming Sequence

- Set Serial Port
- Set up Baud Rate, Parity Bit (None), Data Bit (8 bit), Stop Bit (1 bit).
- Open port.
- Send RS232C command through serial port.
- Check command execution result on RWC2010B screen.
- Send next command after successful execution of the previous command.

If it is difficult to check the execution of the previous command, the next command should be sent after

a few milliseconds.

Tips for Programming

- A colon is used between commands.
- A space is only used between parameter values and commands.
- All commands should be finished by LF (Line Feed, Char(10)).

4.3 Ethernet Interface

4.3.1 Configuration

- 1) Connect LAN port of PC and RWC5020A Ethernet port by RJ45 cable. If the PC and RWC5020A are connected directly, crossover cable must be used.
- 2) Set up the IP address as follows to use crossover cable.

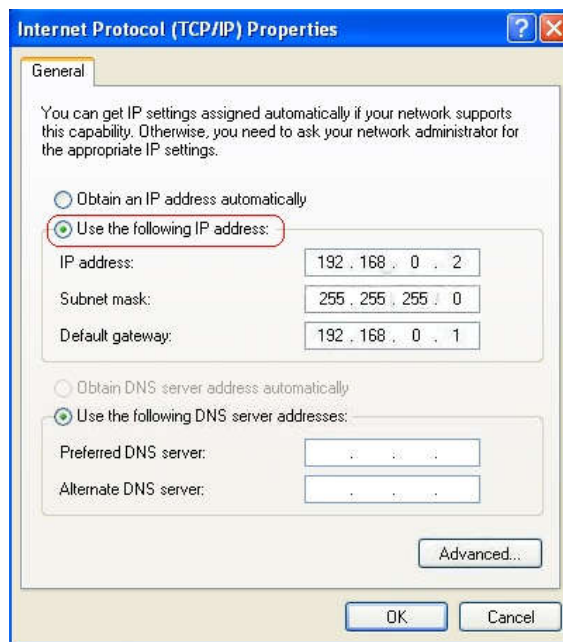

- 3) Turn RWC5020A power ON, press **SYSTEM** key to move to the system configuration screen and configure IP address referring to 2.6.



4.4 Command List (for FW V1.12)

4.4.1 Common Commands

Command	Parameter Range	Description
*IDN?	N/A	Query Identification
*RST	N/A	Preset the equipment fully
*SAVE	1 ~ 10	Save the current parameters setting to memory
*RECALL	1 ~ 10	Recall the saved parameters setting from memory

4.4.2 System Commands

Command	Parameter Range	Description
CONF:TESTER_MODE	EDT GWT NST_TX NST_RX NST_MFG	Configure/Read an operating mode (or Main Menu) of RWC5020A
READ:TESTER_MODE?	Query only	
CONF:REMOTE:LOCK	OFF ON	Lock or Unlock the key input during Remote Control
READ:REMOTE:LOCK?	Query only	
CONF:MOVE_SCREEN	LINK POWER_TIME POWER_CHANNEL SENSITIVITY REMOTE	Configure a screen (or Sub Menu) of RWC5020A to move directly to

4.4.3 Commands for RF Parameters

Command	Parameter Range	Description
---------	-----------------	-------------

CONF:RF:FREQ	400~510, 862~960	Configure/Read CW frequency in MHz for Non-signaling test
READ:RF:FREQ?	Query only	
CONF:RF:TX_POW	-10 ~ -150	Configure/Read TX POWER in dBm
READ:RF:TX_POW?	Query only	
CONF:RF:PATH_LOSS	0 ~ 50	Configure/Read Path Loss in dB
READ:RF:PATH_LOSS?	Query only	
CONF:RF:FREQ_OFFSET	-1000 ~ 1000	Configure/Read the frequency offset in ppm
READ:RF:FREQ_OFFSET?	Query only	
CONF:RF:TIME_OFFSET	-1000 ~ 1000	Configure/Read the time offset in us
READ:RF:TIME_OFFSET?	Query only	
CONF:RF:CH_MASK_0	For EDT, 0x00 ~ 0xFF(EU433, KR920, AS923, RU864) 0x00 ~ 0x7F(EU868,) 0x00 ~ 0x3F(IN865) For GWT, 0x00 ~ 0xFFFF(US/AU/CN) read-only (others)	Configure/Read the channel mask of channel index 0 in both EDT and GWT mode
READ:RF:CH_MASK_0?	Query only	
CONF:RF:CH_MASK_1	0x00 ~ 0xFFFF	Configure/Read the channel mask of channel index 1 (only applicable to US/AU/CN in GWT mode)
READ:RF:CH_MASK_1?	Query only	
CONF:RF:CH_MASK_2	0x00 ~ 0xFFFF	Configure/Read the channel mask of channel index 2 (only applicable to US/AU/CN in GWT mode)
READ:RF:CH_MASK_2?	Query only	
CONF:RF:CH_MASK_3	0x00 ~ 0xFFFF	Configure/Read the channel mask of channel index 3 (only applicable to US/AU/CN in GWT mode)
READ:RF:CH_MASK_3?	Query only	
CONF:RF:CH_MASK_4	0x00 ~ 0xFF (US/AU) 0x00 ~ 0xFFFF (CN)	Configure/Read the channel mask of channel index 4 (only applicable to US/AU/CN in GWT mode)
READ:RF:CH_MASK_4?	Query only	
CONF:RF:CH_MASK_5	0x00 ~ 0xFFFF	Configure/Read the channel mask of channel index 5 (only

READ:RF:CH_MASK_5?	Query only	applicable to CN in GWT mode)
CONF:RF:CH_GROUP	For US/AU, 00~07,64 08~15,65 16~23,55, ... 56~63,71 For CN, 00~07 08~15, 16~23, ... 88~95	Configure/Read the channel group (only applicable to US/AU/CN in EDT mode)
READ:RF:CH_GROUP?	Query only	
CONF:RF:UL_CH	400~510, 862~960	Write Uplink Channel n frequency in MHz; For EDT, editable for param=3 (EU868) param=4 (EU433, KR, AS) other channels are fixed For GWT all channels frequencies are editable
READ:RF:UL_CH?	Query only	Read Uplink Channel n frequency in MHz param=0,1,...,71 (US/AU) param=0,1,...,95 (CN) param=0,1,...,7 (others)
READ:RF:DL_CH?	Query only	Read Downlink Channel n frequency in MHz param=0,1,...,47 (CN) param=0,1,...,7 (others)
CONF:RF:ICA_CH_MODE	INTER_FREQ, SAME_FREQ	Configure/Read the channel mode (only applicable to CN in ICA mode)
READ:RF:ICA_CH_MODE?	Query only	

4.4.4 Commands for PROTOCOL Parameters

Command	Parameter Range	Description
CONF:PROTOCOL:REGION	EU_868 EU_433 US_915 AU_915 CN_470 KR_920 AS_923 IN_865 RU_864	Configure/Read an operating Region of RWC5020A
READ:PROTOCOL:REGION?	Query only	
CONF:PROTOCOL:OPERATOR	PRIVATE SKT	Configure/Read the LoRa service operator in case of KR_920
READ:PROTOCOL:OPERATOR?	Query only	
CONF:PROTOCOL:CLASS	A B C	Configure/Read the class of LoRa device
READ:PROTOCOL:CLASS?	Query only	
CONF:PROTOCOL:ACTIVATION	OTAA ABP	Configure/Read the activation procedure
READ:PROTOCOL:ACTIVATION?	Query only	
CONF:PROTOCOL:SET_TEST_MODE	OFF ON	Configure/Read the flag whether to send the <i>ActivateTestMode</i> command after activation
READ: PROTOCOL:SET_TEST_MODE?	Query only	
CONF:PROTOCOL:BEACON_TIME_OFFSET	-1000 ~ 1000 ms	Configure/Read the beacon time offset.
READ:PROTOCOL:BEACON_TIME_OFFSET?	Query only	
CONF:PROTOCOL:APP_KEY	128-bit HEX value	Configure/Read Application Key
READ:PROTOCOL:APP_KEY?	Query only	
READ:PROTOCOL:REAL_KEY?	Query only	Read the Real Application Key
CONF:PROTOCOL:APPS_KEY	128-bit HEX value	Configure/Read Application Session Key
READ:PROTOCOL:APPS_KEY?	Query only	
CONF:PROTOCOL:NWKS_KEY	128-bit HEX value	Configure/Read Network Session Key
READ:PROTOCOL:NWKS_KEY?	Query only	

CONF:PROTOCOL:CHECK_EUI	NO YES	Configure/Read a flag whether to check DUT's EUI value for activation
READ:PROTOCOL:CHECK_EUI?	Query only	
CONF:PROTOCOL:DEV_EUI	64-bit HEX value	Configure/Read Device EUI value
READ:PROTOCOL:DEV_EUI?	Query only	
CONF:PROTOCOL:APP_EUI	64-bit HEX value	Configure/Read Application EUI value
READ:PROTOCOL:APP_EUI?	Query only	
CONF:PROTOCOL:DEV_ADDR	0 ~ 0xFFFFFFFF	Configure/Read Device Address value
READ:PROTOCOL:DEV_ADDR?	Query only	
CONF:PROTOCOL:NET_ID	0 ~ 0x7F	Configure/Read NET ID value
READ:PROTOCOL:NET_ID?	Query only	
CONF:PROTOCOL:RECEIVE_DELAY	1 ~ 10	Configure/Read RECEIVE_DELAY value in sec
READ:PROTOCOL:RECEIVE_DELAY?	Query only	
CONF:PROTOCOL:PERIODIC_UPLINK	NONE LINK_CHECK_REQ COMFIRMED_UP UNCOMFIRMED_UP DL_COUNTER	Configure/Read the Periodic Uplink message in GWT
READ:PROTOCOL:PERIODIC_UPLINK?	Query only	
CONF:PROTOCOL:INTERVAL	3 ~ 60	Configure/Read the interval in sec between Uplink message defined by Periodic Uplink
READ:PROTOCOL:INTERVAL?	Query only	
CONF:PROTOCOL:UPDATE_FCNT	0 ~ 65535	Configure/Read an frame count value
READ:PROTOCOL:UPDATE_FCNT?	Query only	
CONF:PROTOCOL:ADR	OFF ON	Configure/Read a flag of ADR support
READ:PROTOCOL:ADR?	Query only	
CONF:PROTOCOL:YEAR	2000 ~ 2100	Configure/Read the year value for TIME information
READ:PROTOCOL:YEAR?	Query only	
CONF:PROTOCOL:MONTH	1 ~ 12	Configure/Read the month value for TIME information

READ:PROTOCOL:MONTH?	Query only	
CONF:PROTOCOL:DAY	1 ~ 31	Configure/Read the day value for TIME information
READ:PROTOCOL:DAY?	Query only	
CONF:PROTOCOL:HOURL	1 ~ 23	Configure/Read the hour value for TIME information
READ:PROTOCOL:HOURL?	Query only	
CONF:PROTOCOL:MINUTE	0 ~ 59	Configure/Read the minute value for TIME information
READ:PROTOCOL:MINUTE?	Query only	
CONF:PROTOCOL:SECOND	0 ~ 59	Configure/Read the second value for TIME information
READ:PROTOCOL:SECOND?	Query only	
CONF:PROTOCOL:LINK_MARGIN	0 ~ 254	Configure/Read the link margin value in dB for <i>LinkCheckAns</i>
READ:PROTOCOL:LINK_MARGIN?	Query only	
CONF:PROTOCOL:GATEWAY_CNT	0 ~ 255	Configure/Read the gateway count value for <i>LinkCheckAns</i>
READ:PROTOCOL:GATEWAY_CNT?	Query only	
CONF:PROTOCOL:BATTERY	0 ~ 255	Configure/Read the battery status value for <i>DevStatusAns</i>
READ:PROTOCOL:BATTERY?	Query only	
CONF:PROTOCOL:SNR_MARGIN	-32 ~ 31	Configure/Read the SNR margin value in dB for <i>DevStatusAns</i>
READ:PROTOCOL:SNR_MARGIN?	Query only	
READ:PROTOCOL:ACTIVATION_STATUS?	Query only	Read the status of activation procedure
CONF:PROTOCOL:NETWORK	PRIVATE PUBLIC	Configure/Read the Sync word in LoRa modulation: 0x12 for private network 0x34 for public network
READ:PROTOCOL:NETWORK?	Query only	
CONF:PROTOCOL:DOWNLINK_SLOT	For EDT, RX1 RX2 PING (Class B) For GWT, RX1 RX2 RX1&RX2	Configure/Read the selection of downlink slot (RX window)

READ:PROTOCOL:DOWNLINK_SLOT?	Query only	
CONF:PROTOCOL:UPLINK_DR	DR_0 DR_1 DR_2 ...	Configure/Read Data Rate of Uplink in GWT mode
READ:PROTOCOL:UPLINK_DR?	Query only	
CONF:PROTOCOL:RX1_DR_OFFSET	0 ~ 7	Configure/Read RX1_DR_OFFSET value for <i>RXParamSetupReq</i>
READ:PROTOCOL:RX1_DR_OFFSET?	Query only	
CONF:PROTOCOL:RX2_FREQ	400~510, 862~960	Configure/Read RX2_FREQ value in MHz for <i>RXParamSetupReq</i>
READ:PROTOCOL:RX2_FREQ?	Query only	
CONF:PROTOCOL:RX2_DR	DR_0 DR_1 DR_2 ...	Configure/Read RX2_DR value for <i>RXParamSetupReq</i>
READ:PROTOCOL:RX2_DR?	Query only	
CONF:PROTOCOL:PING_PERIODICITY	0 ~ 7	Configure/Read the periodicity of Ping for Class B
READ:PROTOCOL:PING_PERIODICITY?	Query only	
CONF:PROTOCOL:PROTOCOL_VER	LoRaWAN1.0.2 LoRaWAN1.0.3 LoRaWAN1.1	Configure/Read the protocol version of LoRaWAN
READ:PROTOCOL:PROTOCOL_VER?	Query only	
CONF:PROTOCOL:NWK_KEY	128-bit HEX value	Configure/Read the NwkKey value (LoRaWAN V1.1 only)
READ:PROTOCOL:NWK_KEY?	Query only	
CONF:PROTOCOL:FNWKS_IKEY	128-bit HEX value	Configure/Read the FNwkSIntKey value (LoRaWAN V1.1 only)
READ:PROTOCOL:FNWKS_IKEY?	Query only	
CONF:PROTOCOL:SNWKS_IKEY	128-bit HEX value	Configure/Read the SNwkSIntKey value (LoRaWAN V1.1 only)
READ:PROTOCOL:SNWKS_IKEY?	Query only	
CONF:PROTOCOL:NWKS_EKEY	128-bit HEX value	Configure/Read the NwkSEncKey value (LoRaWAN V1.1 only)
READ:PROTOCOL:NWKS_EKEY?	Query only	

CONF:PROTOCOL:JOIN_EUI	64-bit HEX value	Configure/Read the JoinEUI value (LoRaWAN V1.1 only)
READ:PROTOCOL:JOIN_EUI?	Query only	
CONF:PROTOCOL:UPDATE_NFCNT	0 ~ 65535	Configure/Read the NFCnt value (LoRaWAN V1.1 only)
READ:PROTOCOL:UPDATE_NFCNT?	Query only	
CONF:PROTOCOL:UPDATE_AFCNT	0 ~ 65535	Configure/Read the AFCnt value (LoRaWAN V1.1 only)
READ:PROTOCOL:UPDATE_AFCNT?	Query only	
READ:PROTOCOL:DL_DWELL_TIME?	Query only	Read the downlink dwell time in GWT mode
READ:PROTOCOL:UL_DWELL_TIME?	Query only	Read the uplink dwell time in GWT mode
CONF:PROTOCOL:LATITUDE	-90 ~ 90	Configure/Read the latitude value in Beacon frame for Class B
READ:PROTOCOL:LATITUDE?	Query only	
CONF:PROTOCOL:LONGITUDE	-180 ~ 180	Configure/Read the longitude value in Beacon frame for Class B
READ:PROTOCOL:LONGITUDE?	Query only	
CONF:PROTOCOL:DUT_TYPE	END_DEVICE GATEWAY	Configure/Read the type of DUT, which determines whether the frame is for uplink or downlink
READ:PROTOCOL:DUT_TYPE?	Query only	
CONF:PROTOCOL:MAC_FORMAT	OFF ON	Configure/Read the flag whether to use MAC protocol parameters in LoRa test frame in NST mode
READ:PROTOCOL:MAC_FORMAT?	Query only	
CONF:PROTOCOL:FCNT	0 ~ 65535	Configure/Read the FCnt field of LoRa test frame in NST mode
READ:PROTOCOL:FCNT?	Query only	
CONF:PROTOCOL:FCNT_MODE	FIXED INCREASING	Configure/Read the operation mode of FCnt field of LoRa test frame in NST mode
READ:PROTOCOL:FCNT_MODE?	Query only	
CONF:PROTOCOL:ACK	OFF ON	Configure/Read the ACK field of LoRa test frame in NST mode
READ:PROTOCOL:ACK?	Query only	
CONF:PROTOCOL:ADR_ACK_REQ	OFF ON	Configure/Read the ADRACKReq field of LoRa

READ:PROTOCOL:ADR_ACK_REQ?	Query only	test frame in NST mode
CONF:PROTOCOL:FPENDING	OFF ON	Configure/Read the FPending field of LoRa test frame in NST mode
READ:PROTOCOL:FPENDING?	Query only	
CONF:PROTOCOL:PERIODIC_DOWNLINK	NONE CONFIRMED_DOWN UNCONFIRMED_DOWN	Configure/Read the Periodic Downlink mode for class B in EDT
READ:PROTOCOL: PERIODIC_DOWNLINK?	Query only	
CONF:PROTOCOL:CLAA_MODE	D E	Configure/Read the CLAA mode.
READ:PROTOCOL:CLAA_MODE?	Query only	
CONF:PROTOCOL:NWK_ID	0 ~ 0x7F	Configure/Read the network id.
READ:PROTOCOL:NWK_ID?	Query only	
CONF:PROTOCOL:NET_ID_MSB	0 ~ 0x1FFFF	Configure/Read the MSB of net id.
READ:PROTOCOL:NET_ID_MSB?	Query only	
CONF:PROTOCOL:NWK_ADDR	0 ~ 0x1FFFFFF	Configure/Read the network address.
READ:PROTOCOL:NWK_ADDR?	Query only	
CONF:PROTOCOL:PING_TIME_OFFSET	-1000 ~ 1000 ms	Configure/Read the Ping time offset.
READ:PROTOCOL:PING_TIME_OFFSET?	Query only	

4.4.5 Commands for LINK

RWC5020A supports multi-mac command in a single frame. So some command has <MAC_NUM> field to indicate for which mac command is. RWC5020A supports multi-mac command function.

Command	Parameter Range	Description
EXEC:LINK:RUN	N/A	Start link creation
EXEC:LINK:STOP	N/A	Stop the current link
EXEC:LINK:CLEAR	N/A	Clear the list of link messages and measured power data
READ:LINK:ACTIVATION_STATUS?	Query only	Read the status of activation procedure
READ:INFO_MSG?	Query only	Read the link information messages
EXEC:LINK:MAC_SEND	N/A	Force RWC5020A to send the defined MAC command
CONF:LINK:MAC_CMD_TYPE	UNCONFIRMED CONFIRMED	Configure/Read the message type of MAC Command to send to the DUT
READ:LINK:MAC_CMD_TYPE?	Query only	
CONF:LINK:MAC_CMD_FIELD	PAYLOAD FOPTION	Configure/Read the field where MAC Command is sent
READ:LINK:MAC_CMD_FIELD?	Query only	
CONF:LINK:INSTANT_MAC_CMD <MAC_NUM>	For EDT, DEV_STATUS LINK_ADR DUTY_CYCLE RX_PARAM_SETUP TX_PARAM_SETUP NEW_CHANNEL DL_CHANNEL RX_TIMING_SETUP USER_DEFINED ACTIVATE_TM DEACTIVATE_TM CONFIRMED_TM UNCONFIRMED_TM ECHO_REQUEST_TM TRIGGER_JOIN_REQ_TM ENABLE_CE_MODE_TM BEACON_FREQ PING_SLOT_CH FORCE_REJOIN REJOIN_SETUP ADR_SETUP For GWT, LINK_CHECK DEVICE_TIME DEVICE_MODE RESET_IND	Configure/Read the MAC Command to send to the DUT

READ:LINK:INSTANT_MAC_CMD? <MAC_NUM>	Query only	
CONF:LINK:MIC_ERR_DISPLAY	OFF ON	Configure/Read the flag whether to display erroneous messages in Link Analyzer
READ:LINK:MIC_ERR_DISPLAY?	Query only	
CONF:LINK:ADR_DR <MAC_NUM>	0 ~ 7	Configure/Read DR value for <i>LinkADRReq</i>
READ:LINK:ADR_DR? <MAC_NUM>	Query only	
CONF:LINK:ADR_TXPOW <MAC_NUM>	0 ~ 7	Configure/Read TX power value for <i>LinkADRReq</i>
READ:LINK:ADR_TXPOW? <MAC_NUM>	Query only	
CONF:LINK:ADR_CH_MASK <MAC_NUM>	0x00 ~ 0xFF	Configure/Read CH_MASK value for <i>LinkADRReq</i>
READ:LINK:ADR_CH_MASK? <MAC_NUM>	Query only	
CONF:LINK:ADR_MASK_CTRL <MAC_NUM>	0x00 ~ 0xFF	Configure/Read MASK_CTRL value for <i>LinkADRReq</i>
READ:LINK:ADR_MASK_CTRL? <MAC_NUM>	Query only	
CONF:LINK:ADR_CH_MASK2 <MAC_NUM>	0x00 ~ 0xFF	Configure/Read CH_MASK2 value for <i>LinkADRReq</i> for CLAA mode only
READ:LINK:ADR_CH_MASK2? <MAC_NUM>	Query only	
CONF:LINK:ADR_MASK2_CTRL <MAC_NUM>	0x00 ~ 0xFF	Configure/Read MASK2_CTRL value for <i>LinkADRReq</i> for CLAA mode only
READ:LINK:ADR_MASK2_CTRL? <MAC_NUM>	Query only	
CONF:LINK:ADR_CH_MASK3 <MAC_NUM>	0x00 ~ 0xFF	Configure/Read CH_MASK3 value for <i>LinkADRReq</i> for CLAA mode only
READ:LINK:ADR_CH_MASK3? <MAC_NUM>	Query only	
CONF:LINK:ADR_MASK3_CTRL <MAC_NUM>	0x00 ~ 0xFF	Configure/Read MASK3_CTRL value for <i>LinkADRReq</i> for CLAA mode only
READ:LINK:ADR_MASK3_CTRL? <MAC_NUM>	Query only	
CONF:LINK:ADR_MORE_CH_MASK	OFF, ON	Configure/Read ADR_MORE_CH_MASK value for <i>LinkADRReq</i> for CLAA mode only
READ:LINK:ADR_MORE_CH_MASK?	Query only	
CONF:LINK:ADR_NB_TRANS <MAC_NUM>	0 ~ 15	Configure/Read NbTrans value for <i>LinkADRReq</i>
READ:LINK:ADR_NB_TRANS? <MAC_NUM>	Query only	
CONF:LINK:MAX_DUTY_CYCLE <MAC_NUM>	0 ~ 15	Configure/Read the maximum duty cycle value for

READ:LINK:MAX_DUTY_CYCLE? <MAC_NUM>	Query only	<i>DutyCycleReq</i>
CONF:LINK:MAX_EIRP <MAC_NUM>	8 10 12 ...	Configure/Read the maximum EIRP value in dBm for <i>TXParamSetupReq</i>
READ:LINK:MAX_EIRP? <MAC_NUM>	Query only	
CONF:LINK:UL_DWELL_TIME <MAC_NUM>	NO_LIMIT 400ms	Configure/Read the uplink dwell time value for <i>TXParamSetupReq</i>
READ:LINK:UL_DWELL_TIME? <MAC_NUM>	Query only	
CONF:LINK:DL_DWELL_TIME <MAC_NUM>	NO_LIMIT 400ms	Configure/Read the uplink dwell time value for <i>TXParamSetupReq</i>
READ:LINK:DL_DWELL_TIME? <MAC_NUM>	Query only	
CONF:LINK:NEW_CH_MODE <MAC_NUM>	CREATE DELETE	Configure/Read the mode for <i>NewChannelReq</i>
READ:LINK:NEW_CH_MODE? <MAC_NUM>	Query only	
CONF:LINK:NEW_CH_INDEX <MAC_NUM>	0 ~ 7	Configure/Read the channel index for <i>NewChannelReq</i>
READ:LINK:NEW_CH_INDEX? <MAC_NUM>	Query only	
CONF:LINK:NEW_CH_MAX_DR <MAC_NUM>	0 ~ 7	Configure/Read the maximum DR for <i>NewChannelReq</i>
READ:LINK:NEW_CH_MAX_DR? <MAC_NUM>	Query only	
CONF:LINK:NEW_CH_MIN_DR <MAC_NUM>	0 ~ 7	Configure/Read the minimum DR for <i>NewChannelReq</i>
READ:LINK:NEW_CH_MIN_DR? <MAC_NUM>	Query only	
CONF:LINK:NUM_OF_CMD	1 ~ 3	Configure/Read the number of MAC commands to be sent in a single frame
READ:LINK:NUM_OF_CMD?	Query only	
CONF:LINK:DL_CH_INDEX <MAC_NUM>	0 ~ 7	Configure/Read the channel index for <i>DlChannelReq</i>
READ:LINK:DL_CH_INDEX? <MAC_NUM>	Query only	
CONF:LINK:DL_CH_FREQ <MAC_NUM>	400 ~ 510, 862 ~ 960 MHz	Configure/Read the channel frequency for <i>DlChannelReq</i>
READ:LINK:DL_CH_FREQ? <MAC_NUM>	Query only	

CONF:LINK:PAYLOAD_TYPE	0000_0000 1111_1111 1111_0000 1010_1010 PRBS USER	Configure/Read the Message type of user-defined MAC command
READ:LINK:PAYLOAD_TYPE?	Query only	
CONF:LINK:FPORT	1 ~ 255	Configure/Read the FPORT of user-defined MAC command
READ:LINK:FPORT?	Query only	
CONF:LINK:PAYLOAD_SIZE	1 ~ 128	Configure/Read the Message length in byte of user-defined MAC command
READ:LINK:PAYLOAD_SIZE?	Query only	
CONF:LINK:PAYLOAD	128-byte HEX value	Configure/Read the Message data of user-defined MAC command
READ:LINK:PAYLOAD?	Query only	
CONF:LINK:BEACON_FREQ	0, 862 ~ 960 MHz	Configure/Read the frequency value of Beacon frame
READ:LINK:BEACON_FREQ?	Query only	
CONF:LINK:BEACON_DR	DR_0 ~ DR_6	Configure/Read the data rate of Beacon frame
READ:LINK:BEACON_DR?	Query only	
CONF:LINK:PING_DR	DR_0 ~ DR_6	Configure/Read the index of the Data Rate used for the ping-slot downlinks for <i>PingSlotChannelReq</i>
READ:LINK:PING_DR?	Query only	
CONF:LINK:PING_FREQ	0, 862 ~ 960 MHz	Configure/Read the frequency used for the ping-slot downlinks for <i>PingSlotChannelReq</i>
READ:LINK:PING_FREQ?	Query only	
CONF:LINK:REJOIN_DR <MAC_NUM>	DR_0 ~ DR_6	Configure/Read the Data Rate value for <i>ForceRejoinReq</i>
READ:LINK:REJOIN_DR? <MAC_NUM>	Query only	
CONF:LINK:REJOIN_TYPE <MAC_NUM>	TYPE_0, TYPE_2	Configure/Read the RejoinType value for <i>ForceRejoinReq</i>
READ:LINK:REJOIN_TYPE? <MAC_NUM>	Query only	
CONF:LINK:REJOIN_RETRY <MAC_NUM>	0 ~ 7	Configure/Read the Max_Retries value for

READ:LINK:REJOIN_RETRY? <MAC_NUM>	Query only	<i>ForceRejoinReq</i>
CONF:LINK:REJOIN_PERIOD <MAC_NUM>	0 ~ 7	Configure/Read the Period value for <i>ForceRejoinReq</i>
READ:LINK:REJOIN_PERIOD? <MAC_NUM>	Query only	
CONF:LINK:REJOIN_MAX_TIME_N <MAC_NUM>	0 ~ 15	Configure/Read the MaxTimeN value for <i>RejoinParamSetupReq</i>
READ:LINK:REJOIN_MAX_TIME_N? <MAC_NUM>	Query only	
CONF:LINK:REJOIN_MAX_CNT_N <MAC_NUM>	0 ~ 15	Configure/Read the MaxCountN value for <i>RejoinParamSetupReq</i>
READ:LINK:REJOIN_MAX_CNT_N? <MAC_NUM>	Query only	
CONF:LINK:ADR_LIMIT_EXP <MAC_NUM>	0 ~ 15	Configure/Read the Limit_exp value for <i>ADRParamSetupReq</i> (ADR_ACK_LIMIT=2^Limit_exp)
READ:LINK:ADR_LIMIT_EXP? <MAC_NUM>	Query only	
CONF:LINK:ADR_DELAY_EXP <MAC_NUM>	0 ~ 15	Configure/Read the Delay_exp value for <i>ADRParamSetupReq</i> (ADR_ACK_DELAY=2^Delay_exp)
READ:LINK:ADR_DELAY_EXP? <MAC_NUM>	Query only	
CONF:LINK:TIME_DISPLAY	OFF ON	Configure/Read the flag whether to display Time parameter in Link Analyzer screen
READ:LINK:TIME_DISPLAY?	Query only	
CONF:LINK:FCNT_DISPLAY	OFF ON	Configure/Read the flag whether to display FCnt field in Link Analyzer screen
READ:LINK:FCNT_DISPLAY?	Query only	
CONF:LINK:ADR_DISPLAY	OFF ON	Configure/Read the flag whether to display ADR field in Link Analyzer screen
READ:LINK:ADR_DISPLAY?	Query only	
CONF:LINK:ACK_DISPLAY	OFF ON	Configure/Read the flag whether to display ACK field in Link Analyzer screen
READ:LINK:ACK_DISPLAY?	Query only	
CONF:LINK:CLASS_B_DISPLAY	OFF ON	Configure/Read the flag whether to display Class B field in Link Analyzer screen
READ:LINK:CLASS_B_DISPLAY?	Query only	
CONF:LINK:PORT_DISPLAY	OFF ON	Configure/Read the flag whether to display FPort field

READ:LINK:PORT_DISPLAY?	Query only	in Link Analyzer screen
CONF:LINK:MSG_TYPE_DISPLAY	OFF ON	Configure/Read the flag whether to display Message Type field in Link Analyzer screen
READ:LINK:MSG_TYPE_DISPLAY?	Query only	
CONF:LINK:POW_DISPLAY	OFF ON	Configure/Read the flag whether to display the measured power in Link Analyzer screen
READ:LINK:POW_DISPLAY?	Query only	
CONF:LINK:DR_DISPLAY	OFF ON	Configure/Read the flag whether to display DR value in Link Analyzer screen
READ:LINK:DR_DISPLAY?	Query only	
CONF:LINK:DELAY_DISPLAY	OFF ON	Configure/Read the flag whether to display RxDelay value in Link Analyzer screen
READ:LINK:DELAY_DISPLAY?	Query only	
CONF:LINK:ADRACKREQ_DISPLAY	OFF ON	Configure/Read the flag whether to display ADRACKReq field in Link Analyzer screen
READ:LINK:ADRACKREQ_DISPLAY?	Query only	
CONF:LINK:FPENDING_DISPLAY	OFF ON	Configure/Read the flag whether to display FPending field in Link Analyzer screen
READ:LINK:FPENDING_DISPLAY?	Query only	
CONF:LINK:DWELL_DISPLAY	OFF ON	Configure/Read the flag whether to display dwell time field in Link Analyzer screen
READ:LINK:DWELL_DISPLAY?	Query only	
CONF:LINK:ECHO_LEN	1 ~ 242	Configure/Read the length of payload in bytes in EchoRequest command
READ:LINK:ECHO_LEN?	Query only	
CONF:LINK:CW_TIMEOUT	1 ~ 255	Configure/Read the timeout of CW transmission in Enable Continuous Wave Mode command
READ:LINK:CW_TIMEOUT?	Query only	
CONF:LINK:CW_FREQ	400 ~ 510 MHz 862 ~ 960 MHz	Configure/Read the frequency of CW signal in Enable Continuous Wave Mode command
READ:LINK:CW_FREQ?	Query only	
CONF:LINK:CW_POW	0 ~ 40	Configure/Read the power of CW signal in dBm in Enable

READ:LINK: CW_POW?	Query only	Continuous Wave Mode command
CONF:LINK:MAC_INTERVAL	5 ~ 60	Configure/Read the minimum MAC command interval in sec. This parameter is used for Periodic Downlink in Class B&C
READ:LINK:MAC_INTERVAL?	Query only	Read MAC response information after sending MAC command. For multi-mac response, it requires MAC_NUM parameter.
READ:LINK:MAC_SENDDL_RESULT? <MAC_NUM>	Query only	Read MAC command sending status. There are five status defined (IDLE, STARTED, SCHEDULED, GOT_RSP, TIMEOUT). Refer to following fig.

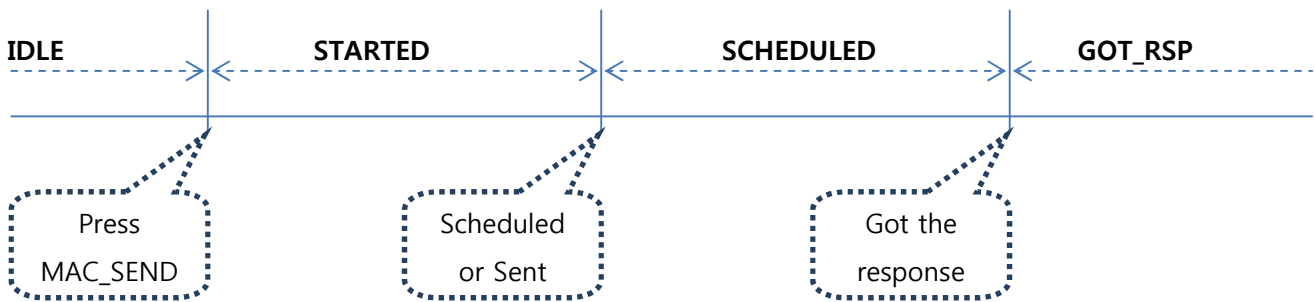

4.4.6 Commands for POW_TIME & POW_CH

Command	Parameter Range	Description
CONF:POWER:SCALE	AUTO MANUAL	Configure/Read the scaling mode of Y-axis
READ:POWER:SCALE?	Query only	
CONF:POWER:MAX_Y	40 ~ -60	Configure/Read the maximum value of Y-axis
READ:POWER:MAX_Y?	Query only	
CONF:POWER:MIN_Y	30 ~ -80	Configure/Read the minimum value of Y-axis
READ:POWER:MIN_Y?	Query only	
READ:POWER:ALL:NUM?	Query only	Read the number of received packets and the maximum,

READ:POWER:ALL:MAX?	Query only	average, or minimum DUT power of all the measured
READ:POWER:ALL:AVG?	Query only	
READ:POWER:ALL:MIN?	Query only	
READ:POWER:SF7:NUM?	Query only	Read the number of received packets and the maximum, average, or minimum DUT power using SF7 of all the measured
READ:POWER:SF7:MAX?	Query only	
READ:POWER:SF7:AVG?	Query only	
READ:POWER:SF7:MIN?	Query only	
READ:POWER:SF8:NUM?	Query only	Read the number of received packets and the maximum, average, or minimum DUT power using SF8 of all the measured
READ:POWER:SF8:MAX?	Query only	
READ:POWER:SF8:AVG?	Query only	
READ:POWER:SF8:MIN?	Query only	
READ:POWER:SF9:NUM?	Query only	Read the number of received packets and the maximum, average, or minimum DUT power using SF9 of all the measured
READ:POWER:SF9:MAX?	Query only	
READ:POWER:SF9:AVG?	Query only	
READ:POWER:SF9:MIN?	Query only	
READ:POWER:SF10:NUM?	Query only	Read the number of received packets and the maximum, average, or minimum DUT power using SF10 of all the measured
READ:POWER:SF10:MAX?	Query only	
READ:POWER:SF10:AVG?	Query only	
READ:POWER:SF10:MIN?	Query only	
READ:POWER:SF11:NUM?	Query only	Read the number of received packets and the maximum, average, or minimum DUT power using SF11 of all the measured
READ:POWER:SF11:MAX?	Query only	
READ:POWER:SF11:AVG?	Query only	
READ:POWER:SF11:MIN?	Query only	
READ:POWER:SF12:NUM?	Query only	Read the number of received packets and the maximum, average, or minimum DUT power using SF12 of all the measured
READ:POWER:SF12:MAX?	Query only	
READ:POWER:SF12:AVG?	Query only	
READ:POWER:SF12:MIN?	Query only	
READ:POWER:CH_0:NUM?	Query only	Read the number of received

READ:POWER:CH_0:MAX?	Query only	packets and the maximum, average, or minimum DUT power using CH_0 of all the measured
READ:POWER:CH_0:AVG?	Query only	
READ:POWER:CH_0:MIN?	Query only	
READ:POWER:CH_1:NUM?	Query only	Read the number of received packets and the maximum, average, or minimum DUT power using CH_1 of all the measured
READ:POWER:CH_1:MAX?	Query only	
READ:POWER:CH_1:AVG?	Query only	
READ:POWER:CH_1:MIN?	Query only	
READ:POWER:CH_2:NUM?	Query only	Read the number of received packets and the maximum, average, or minimum DUT power using CH_2 of all the measured
READ:POWER:CH_2:MAX?	Query only	
READ:POWER:CH_2:AVG?	Query only	
READ:POWER:CH_2:MIN?	Query only	
READ:POWER:CH_3:NUM?	Query only	Read the number of received packets and the maximum, average, or minimum DUT power using CH_3 of all the measured
READ:POWER:CH_3:MAX?	Query only	
READ:POWER:CH_3:AVG?	Query only	
READ:POWER:CH_3:MIN?	Query only	
READ:POWER:CH_4:NUM?	Query only	Read the number of received packets and the maximum, average, or minimum DUT power using CH_4 of all the measured
READ:POWER:CH_4:MAX?	Query only	
READ:POWER:CH_4:AVG?	Query only	
READ:POWER:CH_4:MIN?	Query only	
READ:POWER:CH_5:NUM?	Query only	Read the number of received packets and the maximum, average, or minimum DUT power using CH_5 of all the measured
READ:POWER:CH_5:MAX?	Query only	
READ:POWER:CH_5:AVG?	Query only	
READ:POWER:CH_5:MIN?	Query only	
READ:POWER:CH_6:NUM?	Query only	Read the number of received packets and the maximum, average, or minimum DUT power using CH_6 of all the measured
READ:POWER:CH_6:MAX?	Query only	
READ:POWER:CH_6:AVG?	Query only	
READ:POWER:CH_6:MIN?	Query only	
READ:POWER:CH_7:NUM?	Query only	Read the number of received

READ:POWER:CH_7:MAX?	Query only	packets and the maximum, average, or minimum DUT power using CH_7 of all the measured
READ:POWER:CH_7:AVG?	Query only	
READ:POWER:CH_7:MIN?	Query only	
READ:POWER:RX2:NUM?	Query only	Read the number of received packets and the maximum, average, or minimum DUT power using RX2 of all the measured
READ:POWER:RX2:MAX?	Query only	
READ:POWER:RX2:AVG?	Query only	
READ:POWER:RX2:MIN?	Query only	

4.4.7 Commands for SENSITIVITY

Command	Parameter Range	Description
EXEC:SENSITIVITY:RUN	N/A	Start the sensitivity test
EXEC:SENSITIVITY:STOP	N/A	Stop the sensitivity test
EXEC:SENSITIVITY:RESTART	N/A	Re-start the sensitivity test without stopping
CONF:SENSITIVITY:SCENARIO	CERTI_ECHO NORMAL_UP	Configure/Read the operating mode for sensitivity test
READ:SENSITIVITY:SCENARIO?	Query only	
CONF:SENSITIVITY:PACKET_NUM	5 ~ 1000	Configure/Read the number of repetition for each test point
READ:SENSITIVITY:PACKET_NUM?	Query only	
CONF:SENSITIVITY:START_POW	-10 ~ -143	Configure/Read the start power value
READ:SENSITIVITY:START_POW?	Query only	
READ:SENSITIVITY:STOP_POW?	Query only	Read the stop power value
CONF:SENSITIVITY:NUM_POW	1 ~ 100	Configure/Read the number of power values
READ:SENSITIVITY:NUM_POW?	Query only	
CONF:SENSITIVITY:STEP_POW	1 ~ 20	Configure/Read the step value of power
READ:SENSITIVITY:STEP_POW?	Query only	
CONF:SENSITIVITY:TARGET_PER	0 ~ 0.999	Configure/Read the value of

READ:SENSITIVITY:TARGET_PER?	Query only	users' target PER
READ:SENSITIVITY:STATUS?	Query only	Read the run status of the current test
READ:SENSITIVITY:PROGRESS?	Query only	Read the progress of sensitivity test
READ:SENSITIVITY:LEVEL?	Query only	Read the resultant sensitivity level, [dBm]
READ:SENSITIVITY:PER?	Query only	Read the resultant PER value at sensitivity level
CONF:SENSITIVITY:DOWNLINK_SLOT	For EDT, RX1 RX2 PING (Class B) For GWT, RX1 RX2 RX1&RX2	Configure/Read the selection of downlink slot (RX window)
READ:SENSITIVITY:DOWNLINK_SLOT?	Query only	
CONF:SENSITIVITY:TARGET_CH_MASK	0x01 ~ 0xFF	Configure/Read the Channel mask value to be used in Sensitivity Test. This parameter allows sensitivity testing for specific channels.
READ:SENSITIVITY:TARGET_CH_MASK?	Query only	
CONF:SENSITIVITY:TARGET_DR	DR0 ~ DR7	Configure/Read the DR value to be used in Sensitivity Test
READ:SENSITIVITY:TARGET_DR?	Query only	
CONF:SENSITIVITY:PAYLOAD_TYPE	0000_0000 1111_1111 1111_0000 1010_1010 PRBS USER	Configure/Read the Message type of user-defined MAC command
READ:SENSITIVITY:PAYLOAD_TYPE?	Query only	
CONF:SENSITIVITY:FPORT	1 ~ 255	Configure/Read the FPORT of user-defined MAC command
READ:SENSITIVITY:FPORT?	Query only	
CONF:SENSITIVITY:PAYLOAD_SIZE	1 ~ 128	Configure/Read the Message length in byte of user-defined MAC command
READ:SENSITIVITY:PAYLOAD_SIZE?	Query only	
CONF:SENSITIVITY:PAYLOAD	128-byte HEX value	Configure/Read the Message data of user-defined MAC

READ:SENSITIVITY:PAYLOAD?	Query only	command
CONF:SENSITIVITY:RX2_FREQ	Frequency value in Hz	Configure/Read the RX2 Frequency for RX2 channel sensitivity test
READ:SENSITIVITY:RX2_FREQ?	Query only	

4.4.8 Commands for NST

Command	Parameter Range	Description
EXEC:NST:TX:RUN	N/A	Run the Signal Generator to transmit test packets to DUT
EXEC:NST:TX:STOP	N/A	Stop the Signal Generator
CONF:NST:TX:REPEAT_NUM	0 ~ 10000	Configure/Read the number of repetition; 0 means infinite transmission
READ:NST:TX:REPEAT_NUM?	Query only	
CONF:NST:TX:MODULATION	LORA FSK CW	Configure/Read the TX mode of Non-signaling test
READ:NST:TX:MODULATION?	Query only	
CONF:NST:TX:INTERVAL	0.01 ~ 1000	Configure/Read the interval in sec between consecutive LoRa TX frames
READ:NST:TX:INTERVAL?	Query only	
CONF:NST:TX:BW	500 250 125	Configure/Read the BW of LoRa TX frame
READ:NST:TX:BW?	Query only	
CONF:NST:TX:SF	SF7 SF8 SF9 SF10 SF11 SF12	Configure/Read the Spreading Factor of LoRa TX frame
READ:NST:TX:SF?	Query only	

CONF:NST:TX:CR	4_5 4_6 4_7 4_8 NO_CRC	Configure/Read the Coding Rate of LoRa TX frame
READ:NST:TX:CR?	Query only	
CONF:NST:TX:PREAMBLE_SIZE	2 ~ 12	Configure/Read the Preamble size of LoRa TX frame
READ:NST:TX:PREAMBLE_SIZE?	Query only	
CONF:NST:TX:PAYLOAD_TYPE	0000_0000 1111_1111 1111_0000 1010_1010 PRBS USER	Configure/Read the Payload type of LoRa TX frame
READ:NST:TX:PAYLOAD_TYPE?	Query only	
CONF:NST:TX:PAYLOAD_SIZE	8 ~ 256	Configure/Read the Payload size of LoRa TX frame
READ:NST:TX:PAYLOAD_SIZE?	Query only	
CONF:NST:TX:PAYLOAD	128-byte HEX value	Configure/Read the Payload data of LoRa TX frame
READ:NST:TX:PAYLOAD?	Query only	
CONF:NST:TX:NETWORK	PRIVATE PUBLIC	Configure/Read the Sync word in LoRa modulation: 0x12 for private network 0x34 for public network
READ:NST:TX:NETWORK?	Query only	
CONF:NST:TX:FM_DEVIATION	10 ~ 100 kHz	Configure/Read the FM deviation value for FSK Modulation
READ:NST:TX:FM_DEVIATION?	Query only	
CONF:NST:TX:DATA_RATE	1 ~ 128 kHz	Configure/Read the Data Rate value for FSK Modulation
READ:NST:TX:DATA_RATE?	Query only	
CONF:NST:TX:SYNC_WORD_SIZE	1 ~ 8 byte	Configure/Read the Sync Word size for FSK Modulation
READ:NST:TX:SYNC_WORD_SIZE?	Query only	
CONF:NST:TX:SYNC_WORD		Configure/Read the Sync Word for FSK Modulation
READ:NST:TX:SYNC_WORD?	Query only	
CONF:NST:TX:TX_POLARITY	NORMAL INVERSE	Configure/Read the TX signal polarity for FSK Modulation
READ:NST:TX:TX_POLARITY?	Query only	

CONF:NST:TX:DUT_TYPE	END_DEVICE GATEWAY UNKNOWN	Configure/Read the DUT Type for TX NST test
READ:NST:TX:DUT_TYPE?	Query only	
EXEC:NST:RX:RUN	N/A	Run the Signal Analyzer to receive test packets from DUT
EXEC:NST:RX:STOP	N/A	Stop the Signal Analyzer
CONF:NST:RX:MODE	LORA FSK	Configure/Read the RX mode of Non-signaling test
READ:NST:RX:MODE?	Query only	
CONF:NST:RX:BW	500 250 125	Configure/Read the BW in kHz of LoRa RX frame
READ:NST:RX:BW?	Query only	
CONF:NST:RX:SF	SF7 SF8 SF9 SF10 SF11 SF12 ANY	Configure/Read the Spreading Factor of LoRa RX frame
READ:NST:RX:SF?	Query only	
CONF:NST:RX:NETWORK	PRIVATE PUBLIC	Configure/Read the Sync word in LoRa modulation: 0x12 for private network 0x34 for public network
READ:NST:RX:NETWORK?	Query only	
READ:NST:RX:POW_NUM?	Query only	Read the number of received packets and the maximum, average, or minimum DUT power of all the measured
READ:NST:RX:POW_MAX?	Query only	
READ:NST:RX:POW_AVG?	Query only	
READ:NST:RX:POW_MIN?	Query only	
CONF:NST:RX:DATA_RATE	1 ~ 128 kHz	
READ:NST:RX:DATA_RATE?	Query only	
CONF:NST:RX:SYNC_WORD_SIZE	1 ~ 8 byte	Configure/Read the Sync Word size for FSK Modulation
READ:NST:RX:SYNC_WORD_SIZE?	Query only	
CONF:NST:RX:SYNC_WORD		Configure/Read the Sync Word for FSK Modulation
READ:NST:RX:SYNC_WORD?	Query only	

CONF:NST:RX:TX_POLARITY	NORMAL INVERSE	Configure/Read the RX signal polarity for FSK Modulation
READ:NST:RX:TX_POLARITY?	Query only	
CONF:NST:RX:DUT_TYPE	END_DEVICE GATEWAY UNKNOWN	Configure/Read the DUT Type for RX NST test
READ:NST:RX:DUT_TYPE?	Query only	
CONF:NST:MFG:DUT_TYPE	END_DEVICE GATEWAY UNKNOWN	Configure/Read the DUT Type for MFG NST test
READ:NST:MFG:DUT_TYPE?	Query only	
CONF:NST:MFG:PER_CRITERIA	0.001 ~ 1	Configure/Read the user's criteria of PER in MFG test
READ:NST:MFG:PER_CRITERIA?	Query only	
CONF:NST:MFG:POW_CRITERIA_UPPER	-150 ~ 30	Configure/Read the user's upper criteria of TX Power in MFG test
READ:NST:MFG:POW_CRITERIA_UPPER?	Query only	
CONF:NST:MFG:POW_CRITERIA_LOWER	-150 ~ 30	Configure/Read the user's lower criteria of TX Power in MFG test
READ:NST:MFG:POW_CRITERIA_LOWER?	Query only	
READ:NST:MFG:PER?	Query only	Read the result value of PER measurement in MFG test
READ:NST:MFG:POW?	Query only	Read the result value of Power measurement in MFG test
READ:NST:MFG:STATUS?	Query only	Read the run status in MFG test; STOPPED, IDLE, PASS or FAIL, TIME_OUT, WAIT_REPORT, BUSY
CONF:NST:MFG:TIME_OUT	1 ~ 100	Configure/Read the timeout to wait trigger from DUT in MFG test
READ:NST:MFG:TIME_OUT?	Query only	
CONF:NST:MFG:MODE	LORA FSK	Configure/Read the mode of MFG test
READ:NST:MFG:MODE?	Query only	
CONF:NST:MFG:INTERVAL	0.05 ~ 1000	Configure/Read the interval in sec between consecutive LoRa TX frames in MFG test
READ:NST:MFG:INTERVAL?	Query only	
CONF:NST:MFG:BW	500, 250, 125	Configure/Read the BW in kHz of LoRa TX frame in MFG test
READ:NST:MFG:BW?	Query only	
CONF:NST:MFG:SF	SF7 ~ SF12, ANY	Configure/Read the Spreading Factor of LoRa TX frame in

READ:NST:MFG:SF?	Query only	MFG test
CONF:NST:MFG:CR	4_5, 4_6, 4_7, 4_8, NO_CRC	Configure/Read the Coding Rate of LoRa TX frame in MFG test
READ:NST:MFG:CR?	Query only	
CONF:NST:MFG:PAYLOAD_SIZE	0 ~ 250	Configure/Read the Payload size of LoRa TX frame in MFG test
READ:NST:MFG:PAYLOAD_SIZE?	Query only	
CONF:NST:MFG:PAYLOAD_TYPE	0000_0000 1111_1111 1111_0000 1010_1010 PRBS USER	Configure/Read the Payload type of LoRa TX frame in MFG test
READ:NST:MFG:PAYLOAD_TYPE?	Query only	
CONF:NST:MFG:PREAMBLE_SIZE	2 ~ 12	Configure/Read the Preamble size of LoRa TX frame in MFG test
READ:NST:MFG:PREAMBLE_SIZE?	Query only	
EXEC:NST:MFG:RUN	N/A	Run MFG test
EXEC:NST:MFG:STOP	N/A	Stop MFG test
CONF:NST:MFG:REPEAT_NUM	0:INFINITY 1 ~ 10000	Configure/Read the number of frame transmission in MFG test
READ:NST:MFG:REPEAT_NUM?	Query only	
CONF:NST:MFG:NETWORK	PUBLIC PRIVATE	Configure/Read the Sync word in LoRa modulation in MFG test:
READ:NST:MFG:NETWORK?	Query only	0x12 for private network 0x34 for public network
CONF:NST:MFG:FM_DEVIATION	10 ~ 100 kHz	Configure/Read the FM deviation value for FSK Modulation
READ:NST:MFG:FM_DEVIATION?	Query only	
CONF:NST:MFG:DATA_RATE	1 ~ 128 kHz	Configure/Read the Data Rate value for FSK Modulation
READ:NST:MFG:DATA_RATE?	Query only	
CONF:NST:MFG:SYNC_WORD_SIZE	1 ~ 8 byte	Configure/Read the Sync Word size for FSK Modulation
READ:NST:MFG:SYNC_WORD_SIZE?	Query only	

CONF:NST:MFG:SYNC_WORD		Configure/Read the Sync Word for FSK Modulation
READ:NST:MFG:SYNC_WORD?	Query only	
CONF:NST:MFG:TX_POLARITY	NORMAL INVERSE	Configure/Read the TX signal polarity for FSK Modulation
READ:NST:MFG:TX_POLARITY?	Query only	
CONF:NST:MFG:RX_POLARITY	NORMAL INVERSE	Configure/Read the RX signal polarity for FSK Modulation
READ:NST:MFG:RX_POLARITY?	Query only	
READ:NST:MFG:DUT_INFO?	Query only	Read the user data received from DUT at start of MFG test, e.g. a serial number

4.4.9 Commands for SYSTEM

Command	Parameter Range	Description
READ:SYSTEM:SW_VERSION?	Query only	Read the software version
CONF:SYSTEM:REF_CLK	INT EXT	Configure/Read the selection of source for the reference clock
READ:SYSTEM:REF_CLK?	Query only	
READ:SYSTEM:SERIAL_NUM?	Query only	Read the serial number of RWC5020A
READ:SYSTEM:OPTION_GWT?	Query only	Read the software option information about Gateway Test
READ:SYSTEM:OPTION_EDT?	Query only	Read the software option information about End Device Test
READ:SYSTEM:OPTION_NST?	Query only	Read the software option information about Non-signaling Test
READ:SYSTEM:OPTION_CERTI_EU?	Query only	Read the software option information about Certification test of EU
READ:SYSTEM:OPTION_CERTI_SKT?	Query only	Read the software option information about Certification test of SKT

READ:SYSTEM:OPTION_CERTI_US?	Query only	Read the software option information about Certification test of US
READ:SYSTEM:OPTION_CERTI_AS?	Query only	Read the software option information about Certification test of AS
READ:SYSTEM:OPTION_CERTI_KR?	Query only	Read the software option information about Certification test of KR

V. Revision History

Version	Date	Description																																																		
V1.15	2018.12.14	<ul style="list-style-type: none"> - Firmware version: V1.15 - Updated all pictures according to FW V1.15 - Some Remote command requires more parameters like MAC command index number for multi MAC function. Add this information for multi parameter remote command. <table border="1"> <thead> <tr> <th colspan="2">Commands for PROTOCOL Parameters</th> </tr> </thead> <tbody> <tr> <td>CONF:PROTOCOL:PING_TIME_OFFSET</td> <td>added</td> </tr> <tr> <td>READ:PROTOCOL:PING_TIME_OFFSET?</td> <td>added</td> </tr> <tr> <th colspan="2">Commands for LINK Parameters</th> </tr> <tr> <td>CONF:LINK:MAC_INTERVAL</td> <td>added</td> </tr> <tr> <td>READ:LINK:MAC_INTERVAL?</td> <td>added</td> </tr> <tr> <td>READ:LINK:MAC_SEND_STATUS?</td> <td>added</td> </tr> <tr> <td>READ:LINK:MAC_SEND_RESULT?</td> <td>added</td> </tr> <tr> <th colspan="2">Commands for SENSITIVITY parameters</th> </tr> <tr> <td></td> <td></td> </tr> <tr> <th colspan="2">Commands for RF Parameters</th> </tr> <tr> <td></td> <td></td> </tr> <tr> <th colspan="2">Commands for NST Parameters</th> </tr> <tr> <td></td> <td></td> </tr> </tbody> </table>	Commands for PROTOCOL Parameters		CONF:PROTOCOL:PING_TIME_OFFSET	added	READ:PROTOCOL:PING_TIME_OFFSET?	added	Commands for LINK Parameters		CONF:LINK:MAC_INTERVAL	added	READ:LINK:MAC_INTERVAL?	added	READ:LINK:MAC_SEND_STATUS?	added	READ:LINK:MAC_SEND_RESULT?	added	Commands for SENSITIVITY parameters				Commands for RF Parameters				Commands for NST Parameters																									
Commands for PROTOCOL Parameters																																																				
CONF:PROTOCOL:PING_TIME_OFFSET	added																																																			
READ:PROTOCOL:PING_TIME_OFFSET?	added																																																			
Commands for LINK Parameters																																																				
CONF:LINK:MAC_INTERVAL	added																																																			
READ:LINK:MAC_INTERVAL?	added																																																			
READ:LINK:MAC_SEND_STATUS?	added																																																			
READ:LINK:MAC_SEND_RESULT?	added																																																			
Commands for SENSITIVITY parameters																																																				
Commands for RF Parameters																																																				
Commands for NST Parameters																																																				
V1.14	2018.10.10	<ul style="list-style-type: none"> - Firmware version: V1.14 - Updated all pictures according to FW V1.14 - Change the abbreviation of Region name AU921 → AU915, CN490 → CN470, KR922 → KR920, IN866 → IN865, RU867 → RU864 - Added Any Data Rate type for NST RX and MFG in NST mode - Added or renamed remote commands. See 4.4 for details. <table border="1"> <thead> <tr> <th colspan="2">Commands for PROTOCOL Parameters</th> </tr> </thead> <tbody> <tr> <td>CONF:PROTOCOL:NWK_ID</td> <td>added</td> </tr> <tr> <td>READ:PROTOCOL:NWK_ID?</td> <td>added</td> </tr> <tr> <td>CONF:PROTOCOL:NET_ID_MSB</td> <td>added</td> </tr> <tr> <td>READ:PROTOCOL:NET_ID_MSB?</td> <td>added</td> </tr> <tr> <td>CONF:PROTOCOL:NWK_ADDR</td> <td>added</td> </tr> <tr> <td>READ:PROTOCOL:NWK_ADDR?</td> <td>added</td> </tr> <tr> <td>CONF:PROTOCOL:BEACON_TIME_OFFSET</td> <td>added</td> </tr> <tr> <td>READ:PROTOCOL:BEACON_TIME_OFFSET?</td> <td>added</td> </tr> <tr> <td></td> <td></td> </tr> <tr> <th colspan="2">Commands for LINK Parameters</th> </tr> <tr> <td></td> <td></td> </tr> <tr> <th colspan="2">Commands for SENSITIVITY parameters</th> </tr> <tr> <td>CONF:SENSITIVITY:TARGET_CH_MASK</td> <td>added</td> </tr> <tr> <td>READ:SENSITIVITY:TARGET_CH_MASK?</td> <td>added</td> </tr> <tr> <td>CONF:SENSITIVITY:TARGET_DR</td> <td>renamed from ...:SF</td> </tr> <tr> <td>READ:SENSITIVITY:TARGET_DR?</td> <td>renamed from ...:SF?</td> </tr> <tr> <th colspan="2">Commands for RF Parameters</th> </tr> <tr> <td></td> <td></td> </tr> <tr> <th colspan="2">Commands for NST Parameters</th> </tr> <tr> <td>CONF:NST:TX:FM_DEVIATION</td> <td>added</td> </tr> <tr> <td>READ:NST:TX:FM_DEVIATION?</td> <td>added</td> </tr> <tr> <td>CONF:NST:MFG:FM_DEVIATION</td> <td>added</td> </tr> <tr> <td>READ:NST:MFG:FM_DEVIATION?</td> <td>added</td> </tr> <tr> <td>CONF:NST:TX:DATA_RATE</td> <td>added</td> </tr> </tbody> </table>	Commands for PROTOCOL Parameters		CONF:PROTOCOL:NWK_ID	added	READ:PROTOCOL:NWK_ID?	added	CONF:PROTOCOL:NET_ID_MSB	added	READ:PROTOCOL:NET_ID_MSB?	added	CONF:PROTOCOL:NWK_ADDR	added	READ:PROTOCOL:NWK_ADDR?	added	CONF:PROTOCOL:BEACON_TIME_OFFSET	added	READ:PROTOCOL:BEACON_TIME_OFFSET?	added			Commands for LINK Parameters				Commands for SENSITIVITY parameters		CONF:SENSITIVITY:TARGET_CH_MASK	added	READ:SENSITIVITY:TARGET_CH_MASK?	added	CONF:SENSITIVITY:TARGET_DR	renamed from ...:SF	READ:SENSITIVITY:TARGET_DR?	renamed from ...:SF?	Commands for RF Parameters				Commands for NST Parameters		CONF:NST:TX:FM_DEVIATION	added	READ:NST:TX:FM_DEVIATION?	added	CONF:NST:MFG:FM_DEVIATION	added	READ:NST:MFG:FM_DEVIATION?	added	CONF:NST:TX:DATA_RATE	added
Commands for PROTOCOL Parameters																																																				
CONF:PROTOCOL:NWK_ID	added																																																			
READ:PROTOCOL:NWK_ID?	added																																																			
CONF:PROTOCOL:NET_ID_MSB	added																																																			
READ:PROTOCOL:NET_ID_MSB?	added																																																			
CONF:PROTOCOL:NWK_ADDR	added																																																			
READ:PROTOCOL:NWK_ADDR?	added																																																			
CONF:PROTOCOL:BEACON_TIME_OFFSET	added																																																			
READ:PROTOCOL:BEACON_TIME_OFFSET?	added																																																			
Commands for LINK Parameters																																																				
Commands for SENSITIVITY parameters																																																				
CONF:SENSITIVITY:TARGET_CH_MASK	added																																																			
READ:SENSITIVITY:TARGET_CH_MASK?	added																																																			
CONF:SENSITIVITY:TARGET_DR	renamed from ...:SF																																																			
READ:SENSITIVITY:TARGET_DR?	renamed from ...:SF?																																																			
Commands for RF Parameters																																																				
Commands for NST Parameters																																																				
CONF:NST:TX:FM_DEVIATION	added																																																			
READ:NST:TX:FM_DEVIATION?	added																																																			
CONF:NST:MFG:FM_DEVIATION	added																																																			
READ:NST:MFG:FM_DEVIATION?	added																																																			
CONF:NST:TX:DATA_RATE	added																																																			

		<table border="1"> <tr><td>READ:NST:TX:DATA_RATE?</td><td>added</td></tr> <tr><td>CONF:NST:RX:DATA_RATE</td><td>added</td></tr> <tr><td>READ:NST:RX:DATA_RATE?</td><td>added</td></tr> <tr><td>CONF:NST:MFG:DATA_RATE</td><td>added</td></tr> <tr><td>READ:NST:MFG:DATA_RATE?</td><td>added</td></tr> <tr><td>CONF:NST:TX:SYNC_WORD_SIZE</td><td>added</td></tr> <tr><td>READ:NST:TX:SYNC_WORD_SIZE?</td><td>added</td></tr> <tr><td>CONF:NST:RX:SYNC_WORD_SIZE</td><td>added</td></tr> <tr><td>READ:NST:RX:SYNC_WORD_SIZE?</td><td>added</td></tr> <tr><td>CONF:NST:MFG:SYNC_WORD_SIZE</td><td>added</td></tr> <tr><td>READ:NST:MFG:SYNC_WORD_SIZE?</td><td>added</td></tr> <tr><td>CONF:NST:TX:SYNC_WORD</td><td>added</td></tr> <tr><td>READ:NST:TX:SYNC_WORD?</td><td>added</td></tr> <tr><td>CONF:NST:RX:SYNC_WORD</td><td>added</td></tr> <tr><td>READ:NST:RX:SYNC_WORD?</td><td>added</td></tr> <tr><td>CONF:NST:MFG:SYNC_WORD</td><td>added</td></tr> <tr><td>READ:NST:MFG:SYNC_WORD?</td><td>added</td></tr> <tr><td>CONF:NST:TX:MODULATION</td><td>renamed from ...:MODE</td></tr> <tr><td>READ:NST:TX:MODULATION?</td><td>renamed from ...:MODE?</td></tr> <tr><td>CONF:NST:RX:MODULATION</td><td>added</td></tr> <tr><td>READ:NST:RX:MODULATION?</td><td>added</td></tr> <tr><td>CONF:NST:MFG:MODULATION</td><td>added</td></tr> <tr><td>READ:NST:MFG:MODULATION?</td><td>added</td></tr> <tr><td>CONF:NST:TX:DUT_TYPE</td><td>renamed from ...:PROTOCOL:DUT_TYPE</td></tr> <tr><td>READ:NST:TX:DUT_TYPE?</td><td>renamed from ...:PROTOCOL:DUT_TYPE?</td></tr> <tr><td>CONF:NST:RX:DUT_TYPE</td><td>added</td></tr> <tr><td>READ:NST:RX:DUT_TYPE?</td><td>added</td></tr> <tr><td>CONF:NST:MFG:DUT_TYPE</td><td>added</td></tr> <tr><td>READ:NST:MFG:DUT_TYPE?</td><td>added</td></tr> <tr><td>CONF:NST:TX:TX_POLARITY</td><td>added</td></tr> <tr><td>READ:NST:TX:TX_POLARITY?</td><td>added</td></tr> <tr><td>CONF:NST:RX:RX_POLARITY</td><td>added</td></tr> <tr><td>READ:NST:RX:RX_POLARITY?</td><td>added</td></tr> <tr><td>CONF:NST:MFG:TX_POLARITY</td><td>added</td></tr> <tr><td>READ:NST:MFG:TX_POLARITY?</td><td>added</td></tr> <tr><td>CONF:NST:MFG:RX_POLARITY</td><td>added</td></tr> <tr><td>READ:NST:MFG:RX_POLARITY?</td><td>added</td></tr> </table>	READ:NST:TX:DATA_RATE?	added	CONF:NST:RX:DATA_RATE	added	READ:NST:RX:DATA_RATE?	added	CONF:NST:MFG:DATA_RATE	added	READ:NST:MFG:DATA_RATE?	added	CONF:NST:TX:SYNC_WORD_SIZE	added	READ:NST:TX:SYNC_WORD_SIZE?	added	CONF:NST:RX:SYNC_WORD_SIZE	added	READ:NST:RX:SYNC_WORD_SIZE?	added	CONF:NST:MFG:SYNC_WORD_SIZE	added	READ:NST:MFG:SYNC_WORD_SIZE?	added	CONF:NST:TX:SYNC_WORD	added	READ:NST:TX:SYNC_WORD?	added	CONF:NST:RX:SYNC_WORD	added	READ:NST:RX:SYNC_WORD?	added	CONF:NST:MFG:SYNC_WORD	added	READ:NST:MFG:SYNC_WORD?	added	CONF:NST:TX:MODULATION	renamed from ...:MODE	READ:NST:TX:MODULATION?	renamed from ...:MODE?	CONF:NST:RX:MODULATION	added	READ:NST:RX:MODULATION?	added	CONF:NST:MFG:MODULATION	added	READ:NST:MFG:MODULATION?	added	CONF:NST:TX:DUT_TYPE	renamed from ...:PROTOCOL:DUT_TYPE	READ:NST:TX:DUT_TYPE?	renamed from ...:PROTOCOL:DUT_TYPE?	CONF:NST:RX:DUT_TYPE	added	READ:NST:RX:DUT_TYPE?	added	CONF:NST:MFG:DUT_TYPE	added	READ:NST:MFG:DUT_TYPE?	added	CONF:NST:TX:TX_POLARITY	added	READ:NST:TX:TX_POLARITY?	added	CONF:NST:RX:RX_POLARITY	added	READ:NST:RX:RX_POLARITY?	added	CONF:NST:MFG:TX_POLARITY	added	READ:NST:MFG:TX_POLARITY?	added	CONF:NST:MFG:RX_POLARITY	added	READ:NST:MFG:RX_POLARITY?	added
READ:NST:TX:DATA_RATE?	added																																																																											
CONF:NST:RX:DATA_RATE	added																																																																											
READ:NST:RX:DATA_RATE?	added																																																																											
CONF:NST:MFG:DATA_RATE	added																																																																											
READ:NST:MFG:DATA_RATE?	added																																																																											
CONF:NST:TX:SYNC_WORD_SIZE	added																																																																											
READ:NST:TX:SYNC_WORD_SIZE?	added																																																																											
CONF:NST:RX:SYNC_WORD_SIZE	added																																																																											
READ:NST:RX:SYNC_WORD_SIZE?	added																																																																											
CONF:NST:MFG:SYNC_WORD_SIZE	added																																																																											
READ:NST:MFG:SYNC_WORD_SIZE?	added																																																																											
CONF:NST:TX:SYNC_WORD	added																																																																											
READ:NST:TX:SYNC_WORD?	added																																																																											
CONF:NST:RX:SYNC_WORD	added																																																																											
READ:NST:RX:SYNC_WORD?	added																																																																											
CONF:NST:MFG:SYNC_WORD	added																																																																											
READ:NST:MFG:SYNC_WORD?	added																																																																											
CONF:NST:TX:MODULATION	renamed from ...:MODE																																																																											
READ:NST:TX:MODULATION?	renamed from ...:MODE?																																																																											
CONF:NST:RX:MODULATION	added																																																																											
READ:NST:RX:MODULATION?	added																																																																											
CONF:NST:MFG:MODULATION	added																																																																											
READ:NST:MFG:MODULATION?	added																																																																											
CONF:NST:TX:DUT_TYPE	renamed from ...:PROTOCOL:DUT_TYPE																																																																											
READ:NST:TX:DUT_TYPE?	renamed from ...:PROTOCOL:DUT_TYPE?																																																																											
CONF:NST:RX:DUT_TYPE	added																																																																											
READ:NST:RX:DUT_TYPE?	added																																																																											
CONF:NST:MFG:DUT_TYPE	added																																																																											
READ:NST:MFG:DUT_TYPE?	added																																																																											
CONF:NST:TX:TX_POLARITY	added																																																																											
READ:NST:TX:TX_POLARITY?	added																																																																											
CONF:NST:RX:RX_POLARITY	added																																																																											
READ:NST:RX:RX_POLARITY?	added																																																																											
CONF:NST:MFG:TX_POLARITY	added																																																																											
READ:NST:MFG:TX_POLARITY?	added																																																																											
CONF:NST:MFG:RX_POLARITY	added																																																																											
READ:NST:MFG:RX_POLARITY?	added																																																																											
V1.13	2018.07.19	<ul style="list-style-type: none"> - Firmware version: V1.13 - Updated all pictures according to FW V1.13 - Added a function of Periodic Downlink in Class C mode of EDT - Added or renamed remote commands. See 4.4 for details. <table border="1"> <tr><td colspan="2">Commands for PROTOCOL Parameters</td></tr> <tr><td>CONF:PROTOCOL:SET_TEST_MODE</td><td>added</td></tr> <tr><td>READ:PROTOCOL:SET_TEST_MODE?</td><td>added</td></tr> <tr><td>CONF:PROTOCOL:SET_CH_MASK</td><td>added</td></tr> <tr><td>READ:PROTOCOL:SET_CH_MASK?</td><td>added</td></tr> <tr><td>CONF:PROTOCOL:CLAA_MODE</td><td>added</td></tr> <tr><td>READ:PROTOCOL:CLAA_MODE?</td><td>added</td></tr> <tr><td>CONF:PROTOCOL:PERIODIC_DOWNLINK</td><td>added</td></tr> <tr><td>READ:PROTOCOL:PERIODIC_DOWNLINK?</td><td>added</td></tr> <tr><td colspan="2">Commands for LINK Parameters</td></tr> <tr><td>CONF:LINK:SET_TM_AT_OTAA</td><td>deleted</td></tr> <tr><td>READ:LINK:SET_TM_AT_OTAA?</td><td>deleted</td></tr> <tr><td>CONF:LINK:SET_CH_AT_OTAA</td><td>deleted</td></tr> <tr><td>READ:LINK:SET_CH_AT_OTAA?</td><td>deleted</td></tr> <tr><td>CONF:LINK:ADR_MORE_CH_MASK</td><td>added</td></tr> <tr><td>READ:LINK:ADR_MORE_CH_MASK?</td><td>added</td></tr> <tr><td>CONF:LINK:ADR_CH_MASK2</td><td>added</td></tr> <tr><td>READ:LINK:ADR_CH_MASK2?</td><td>added</td></tr> <tr><td>CONF:LINK:ADR_CH_MASK3</td><td>added</td></tr> <tr><td>READ:LINK:ADR_CH_MASK3?</td><td>added</td></tr> <tr><td>CONF:LINK:ADR_MASK2_CTRL</td><td>added</td></tr> <tr><td>READ:LINK:ADR_MASK2_CTRL?</td><td>added</td></tr> </table>	Commands for PROTOCOL Parameters		CONF:PROTOCOL:SET_TEST_MODE	added	READ:PROTOCOL:SET_TEST_MODE?	added	CONF:PROTOCOL:SET_CH_MASK	added	READ:PROTOCOL:SET_CH_MASK?	added	CONF:PROTOCOL:CLAA_MODE	added	READ:PROTOCOL:CLAA_MODE?	added	CONF:PROTOCOL:PERIODIC_DOWNLINK	added	READ:PROTOCOL:PERIODIC_DOWNLINK?	added	Commands for LINK Parameters		CONF:LINK:SET_TM_AT_OTAA	deleted	READ:LINK:SET_TM_AT_OTAA?	deleted	CONF:LINK:SET_CH_AT_OTAA	deleted	READ:LINK:SET_CH_AT_OTAA?	deleted	CONF:LINK:ADR_MORE_CH_MASK	added	READ:LINK:ADR_MORE_CH_MASK?	added	CONF:LINK:ADR_CH_MASK2	added	READ:LINK:ADR_CH_MASK2?	added	CONF:LINK:ADR_CH_MASK3	added	READ:LINK:ADR_CH_MASK3?	added	CONF:LINK:ADR_MASK2_CTRL	added	READ:LINK:ADR_MASK2_CTRL?	added																														
Commands for PROTOCOL Parameters																																																																												
CONF:PROTOCOL:SET_TEST_MODE	added																																																																											
READ:PROTOCOL:SET_TEST_MODE?	added																																																																											
CONF:PROTOCOL:SET_CH_MASK	added																																																																											
READ:PROTOCOL:SET_CH_MASK?	added																																																																											
CONF:PROTOCOL:CLAA_MODE	added																																																																											
READ:PROTOCOL:CLAA_MODE?	added																																																																											
CONF:PROTOCOL:PERIODIC_DOWNLINK	added																																																																											
READ:PROTOCOL:PERIODIC_DOWNLINK?	added																																																																											
Commands for LINK Parameters																																																																												
CONF:LINK:SET_TM_AT_OTAA	deleted																																																																											
READ:LINK:SET_TM_AT_OTAA?	deleted																																																																											
CONF:LINK:SET_CH_AT_OTAA	deleted																																																																											
READ:LINK:SET_CH_AT_OTAA?	deleted																																																																											
CONF:LINK:ADR_MORE_CH_MASK	added																																																																											
READ:LINK:ADR_MORE_CH_MASK?	added																																																																											
CONF:LINK:ADR_CH_MASK2	added																																																																											
READ:LINK:ADR_CH_MASK2?	added																																																																											
CONF:LINK:ADR_CH_MASK3	added																																																																											
READ:LINK:ADR_CH_MASK3?	added																																																																											
CONF:LINK:ADR_MASK2_CTRL	added																																																																											
READ:LINK:ADR_MASK2_CTRL?	added																																																																											

		<table border="1"> <tr> <td>CONF:LINK:ADR_MASK3_CTRL READ:LINK:ADR_MASK3_CTRL?</td> <td>added added</td> </tr> <tr> <td>CONF:LINK:DWELL_DISPLAY READ:LINK:DWELL_DISPLAY?</td> <td>added added</td> </tr> <tr> <td colspan="2">Commands for SENSITIVITY parameters</td> </tr> <tr> <td>CONF:SENSITIVITY:RX2_FREQ READ: SENSITIVITY:RX2_FREQ?</td> <td>added added</td> </tr> <tr> <td colspan="2">Commands for RF Parameters</td> </tr> <tr> <td>CONF:RF:CH_GROUP READ: RF:CH_GROUP?</td> <td>renamed from ...:CH_GROUP_A renamed from ...:CH_GROUP_A?</td> </tr> <tr> <td>CONF:RF:CH_GROUP_B READ:RF:CH_GROUP_B?</td> <td>deleted deleted</td> </tr> <tr> <td>CONF:RF:CH_MODE READ:RF:CH_MODE?</td> <td>added added</td> </tr> </table>	CONF:LINK:ADR_MASK3_CTRL READ:LINK:ADR_MASK3_CTRL?	added added	CONF:LINK:DWELL_DISPLAY READ:LINK:DWELL_DISPLAY?	added added	Commands for SENSITIVITY parameters		CONF:SENSITIVITY:RX2_FREQ READ: SENSITIVITY:RX2_FREQ?	added added	Commands for RF Parameters		CONF:RF:CH_GROUP READ: RF:CH_GROUP?	renamed from ...:CH_GROUP_A renamed from ...:CH_GROUP_A?	CONF:RF:CH_GROUP_B READ:RF:CH_GROUP_B?	deleted deleted	CONF:RF:CH_MODE READ:RF:CH_MODE?	added added																								
CONF:LINK:ADR_MASK3_CTRL READ:LINK:ADR_MASK3_CTRL?	added added																																									
CONF:LINK:DWELL_DISPLAY READ:LINK:DWELL_DISPLAY?	added added																																									
Commands for SENSITIVITY parameters																																										
CONF:SENSITIVITY:RX2_FREQ READ: SENSITIVITY:RX2_FREQ?	added added																																									
Commands for RF Parameters																																										
CONF:RF:CH_GROUP READ: RF:CH_GROUP?	renamed from ...:CH_GROUP_A renamed from ...:CH_GROUP_A?																																									
CONF:RF:CH_GROUP_B READ:RF:CH_GROUP_B?	deleted deleted																																									
CONF:RF:CH_MODE READ:RF:CH_MODE?	added added																																									
V1.12	2018.04.20	<p>- Firmware version: V1.12 - Updated all pictures according to FW V1.12 - Added explanation about new MAC commands of test mode; CONFIRMED_TM, UNCONFIRMED_TM, ECHO_REQUEST_TM, TRIGGER_JOIN_REQ_TM, ENABLE_CW_MODE_TM. See 3.3.3 for details. - Added the MFG function in NST mode for automated manufacturing tests. See 3.19 for details. - Added or renamed remote commands. See 4.4 for details.</p> <table border="1"> <tr> <td colspan="2">Commands for PROTOCOL Parameters</td> </tr> <tr> <td>CONF:PROTOCOL:DUT_TYPE READ:PROTOCOL:DUT_TYPE?</td> <td>renamed from ...:MESSAGE_TYPE renamed from ...:MESSAGE_TYPE?</td> </tr> <tr> <td colspan="2">Commands for LINK Parameters</td> </tr> <tr> <td>CONF:LINK:INSTANT_MAC_CMD</td> <td>parameters added; CONFIRMED_TM, UNCONFIRMED_TM, ECHO_REQUEST_TM, TRIGGER_JOIN_REQ_TM, ENABLE CE MODE_TM</td> </tr> <tr> <td>CONF:LINK:TIME_DISPLAY READ:LINK:TIME_DISPLAY?</td> <td>added added</td> </tr> <tr> <td>CONF:LINK:FCNT_DISPLAY READ:LINK:FCNT_DISPLAY?</td> <td>added added</td> </tr> <tr> <td>CONF:LINK:ADR_DISPLAY READ:LINK:ADR_DISPLAY?</td> <td>added added</td> </tr> <tr> <td>CONF:LINK:ACK_DISPLAY READ:LINK:ACK_DISPLAY?</td> <td>added added</td> </tr> <tr> <td>CONF:LINK:CLASS_B_DISPLAY READ:LINK:CLASS_B_DISPLAY?</td> <td>added added</td> </tr> <tr> <td>CONF:LINK:PORT_DISPLAY READ:LINK:PORT_DISPLAY?</td> <td>added added</td> </tr> <tr> <td>CONF:LINK:MSG_TYPE_DISPLAY READ:LINK:MSG_TYPE_DISPLAY?</td> <td>added added</td> </tr> <tr> <td>CONF:LINK:POW_DISPLAY READ:LINK:POW_DISPLAY?</td> <td>added added</td> </tr> <tr> <td>CONF:LINK:DR_DISPLAY READ:LINK:DR_DISPLAY?</td> <td>added added</td> </tr> <tr> <td>CONF:LINK:DELAY_DISPLAY READ:LINK:DELAY_DISPLAY?</td> <td>added added</td> </tr> <tr> <td>CONF:LINK:ADRACKREQ_DISPLAY READ:LINK:ADRACKREQ_DISPLAY?</td> <td>added added</td> </tr> <tr> <td>CONF:LINK:FPENDING_DISPLAY READ:LINK:FPENDING_DISPLAY?</td> <td>added added</td> </tr> <tr> <td>CONF:LINK:ECHO_LEN READ:LINK:ECHO_LEN?</td> <td>added added</td> </tr> <tr> <td>CONF:LINK:CW_TIMEOUT READ:LINK:CW_TIMEOUT?</td> <td>added added</td> </tr> <tr> <td>CONF:LINK:CW_FREQ READ:LINK:CW_FREQ?</td> <td>added added</td> </tr> <tr> <td>CONF:LINK:CW_POW</td> <td>added</td> </tr> </table>	Commands for PROTOCOL Parameters		CONF:PROTOCOL:DUT_TYPE READ:PROTOCOL:DUT_TYPE?	renamed from ...:MESSAGE_TYPE renamed from ...:MESSAGE_TYPE?	Commands for LINK Parameters		CONF:LINK:INSTANT_MAC_CMD	parameters added; CONFIRMED_TM, UNCONFIRMED_TM, ECHO_REQUEST_TM, TRIGGER_JOIN_REQ_TM, ENABLE CE MODE_TM	CONF:LINK:TIME_DISPLAY READ:LINK:TIME_DISPLAY?	added added	CONF:LINK:FCNT_DISPLAY READ:LINK:FCNT_DISPLAY?	added added	CONF:LINK:ADR_DISPLAY READ:LINK:ADR_DISPLAY?	added added	CONF:LINK:ACK_DISPLAY READ:LINK:ACK_DISPLAY?	added added	CONF:LINK:CLASS_B_DISPLAY READ:LINK:CLASS_B_DISPLAY?	added added	CONF:LINK:PORT_DISPLAY READ:LINK:PORT_DISPLAY?	added added	CONF:LINK:MSG_TYPE_DISPLAY READ:LINK:MSG_TYPE_DISPLAY?	added added	CONF:LINK:POW_DISPLAY READ:LINK:POW_DISPLAY?	added added	CONF:LINK:DR_DISPLAY READ:LINK:DR_DISPLAY?	added added	CONF:LINK:DELAY_DISPLAY READ:LINK:DELAY_DISPLAY?	added added	CONF:LINK:ADRACKREQ_DISPLAY READ:LINK:ADRACKREQ_DISPLAY?	added added	CONF:LINK:FPENDING_DISPLAY READ:LINK:FPENDING_DISPLAY?	added added	CONF:LINK:ECHO_LEN READ:LINK:ECHO_LEN?	added added	CONF:LINK:CW_TIMEOUT READ:LINK:CW_TIMEOUT?	added added	CONF:LINK:CW_FREQ READ:LINK:CW_FREQ?	added added	CONF:LINK:CW_POW	added
Commands for PROTOCOL Parameters																																										
CONF:PROTOCOL:DUT_TYPE READ:PROTOCOL:DUT_TYPE?	renamed from ...:MESSAGE_TYPE renamed from ...:MESSAGE_TYPE?																																									
Commands for LINK Parameters																																										
CONF:LINK:INSTANT_MAC_CMD	parameters added; CONFIRMED_TM, UNCONFIRMED_TM, ECHO_REQUEST_TM, TRIGGER_JOIN_REQ_TM, ENABLE CE MODE_TM																																									
CONF:LINK:TIME_DISPLAY READ:LINK:TIME_DISPLAY?	added added																																									
CONF:LINK:FCNT_DISPLAY READ:LINK:FCNT_DISPLAY?	added added																																									
CONF:LINK:ADR_DISPLAY READ:LINK:ADR_DISPLAY?	added added																																									
CONF:LINK:ACK_DISPLAY READ:LINK:ACK_DISPLAY?	added added																																									
CONF:LINK:CLASS_B_DISPLAY READ:LINK:CLASS_B_DISPLAY?	added added																																									
CONF:LINK:PORT_DISPLAY READ:LINK:PORT_DISPLAY?	added added																																									
CONF:LINK:MSG_TYPE_DISPLAY READ:LINK:MSG_TYPE_DISPLAY?	added added																																									
CONF:LINK:POW_DISPLAY READ:LINK:POW_DISPLAY?	added added																																									
CONF:LINK:DR_DISPLAY READ:LINK:DR_DISPLAY?	added added																																									
CONF:LINK:DELAY_DISPLAY READ:LINK:DELAY_DISPLAY?	added added																																									
CONF:LINK:ADRACKREQ_DISPLAY READ:LINK:ADRACKREQ_DISPLAY?	added added																																									
CONF:LINK:FPENDING_DISPLAY READ:LINK:FPENDING_DISPLAY?	added added																																									
CONF:LINK:ECHO_LEN READ:LINK:ECHO_LEN?	added added																																									
CONF:LINK:CW_TIMEOUT READ:LINK:CW_TIMEOUT?	added added																																									
CONF:LINK:CW_FREQ READ:LINK:CW_FREQ?	added added																																									
CONF:LINK:CW_POW	added																																									

		<table border="1"> <tr> <td>READ:LINK:CW POW?</td> <td>added</td> </tr> <tr> <td colspan="2">Commands for NST Parameters</td> </tr> <tr> <td>CONF:NST:MFG:PER_CRITERIA</td> <td>added</td> </tr> <tr> <td>READ:NST:MFG:PER_CRITERIA?</td> <td>added</td> </tr> <tr> <td>CONF:NST:MFG:POW_CRITERIA_UPPER</td> <td>added</td> </tr> <tr> <td>READ:NST:MFG:POW_CRITERIA_UPPER?</td> <td>added</td> </tr> <tr> <td>CONF:NST:MFG:POW_CRITERIA_LOWER</td> <td>added</td> </tr> <tr> <td>READ:NST:MFG:POW_CRITERIA_LOWER?</td> <td>added</td> </tr> <tr> <td>READ:NST:MFG:PER?</td> <td>added</td> </tr> <tr> <td>READ:NST:MFG:POW?</td> <td>added</td> </tr> <tr> <td>READ:NST:MFG:STATUS?</td> <td>added</td> </tr> <tr> <td>CONF:NST:MFG:TIME_OUT</td> <td>added</td> </tr> <tr> <td>READ:NST:MFG:TIME_OUT?</td> <td>added</td> </tr> <tr> <td>CONF:NST:MFG:MODE</td> <td>added</td> </tr> <tr> <td>READ:NST:MFG:MODE?</td> <td>added</td> </tr> <tr> <td>CONF:NST:MFG:INTERVAL</td> <td>added</td> </tr> <tr> <td>READ:NST:MFG:INTERVAL?</td> <td>added</td> </tr> <tr> <td>CONF:NST:MFG:BW</td> <td>added</td> </tr> <tr> <td>READ:NST:MFG:BW?</td> <td>added</td> </tr> <tr> <td>CONF:NST:MFG:SF</td> <td>added</td> </tr> <tr> <td>READ:NST:MFG:SF?</td> <td>added</td> </tr> <tr> <td>CONF:NST:MFG:CR</td> <td>added</td> </tr> <tr> <td>READ:NST:MFG:CR?</td> <td>added</td> </tr> <tr> <td>CONF:NST:MFG:PAYLOAD_SIZE</td> <td>added</td> </tr> <tr> <td>READ:NST:MFG:PAYLOAD_SIZE?</td> <td>added</td> </tr> <tr> <td>CONF:NST:MFG:PAYLOAD_TYPE</td> <td>added</td> </tr> <tr> <td>READ:NST:MFG:PAYLOAD_TYPE?</td> <td>added</td> </tr> <tr> <td>CONF:NST:MFG:PREAMBLE_SIZE</td> <td>added</td> </tr> <tr> <td>READ:NST:MFG:PREAMBLE_SIZE?</td> <td>added</td> </tr> <tr> <td>EXEC:NST:MFG:RUN</td> <td>added</td> </tr> <tr> <td>EXEC:NST:MFG:STOP</td> <td>added</td> </tr> <tr> <td>CONF:NST:MFG:REPEAT_NUM</td> <td>added</td> </tr> <tr> <td>READ:NST:MFG:REPEAT_NUM?</td> <td>added</td> </tr> <tr> <td>CONF:NST:MFG:NETWORK</td> <td>added</td> </tr> <tr> <td>READ:NST:MFG:NETWORK?</td> <td>added</td> </tr> <tr> <td>READ:NST:MFG:DUT_INFO?</td> <td>added</td> </tr> </table>	READ:LINK:CW POW?	added	Commands for NST Parameters		CONF:NST:MFG:PER_CRITERIA	added	READ:NST:MFG:PER_CRITERIA?	added	CONF:NST:MFG:POW_CRITERIA_UPPER	added	READ:NST:MFG:POW_CRITERIA_UPPER?	added	CONF:NST:MFG:POW_CRITERIA_LOWER	added	READ:NST:MFG:POW_CRITERIA_LOWER?	added	READ:NST:MFG:PER?	added	READ:NST:MFG:POW?	added	READ:NST:MFG:STATUS?	added	CONF:NST:MFG:TIME_OUT	added	READ:NST:MFG:TIME_OUT?	added	CONF:NST:MFG:MODE	added	READ:NST:MFG:MODE?	added	CONF:NST:MFG:INTERVAL	added	READ:NST:MFG:INTERVAL?	added	CONF:NST:MFG:BW	added	READ:NST:MFG:BW?	added	CONF:NST:MFG:SF	added	READ:NST:MFG:SF?	added	CONF:NST:MFG:CR	added	READ:NST:MFG:CR?	added	CONF:NST:MFG:PAYLOAD_SIZE	added	READ:NST:MFG:PAYLOAD_SIZE?	added	CONF:NST:MFG:PAYLOAD_TYPE	added	READ:NST:MFG:PAYLOAD_TYPE?	added	CONF:NST:MFG:PREAMBLE_SIZE	added	READ:NST:MFG:PREAMBLE_SIZE?	added	EXEC:NST:MFG:RUN	added	EXEC:NST:MFG:STOP	added	CONF:NST:MFG:REPEAT_NUM	added	READ:NST:MFG:REPEAT_NUM?	added	CONF:NST:MFG:NETWORK	added	READ:NST:MFG:NETWORK?	added	READ:NST:MFG:DUT_INFO?	added
READ:LINK:CW POW?	added																																																																									
Commands for NST Parameters																																																																										
CONF:NST:MFG:PER_CRITERIA	added																																																																									
READ:NST:MFG:PER_CRITERIA?	added																																																																									
CONF:NST:MFG:POW_CRITERIA_UPPER	added																																																																									
READ:NST:MFG:POW_CRITERIA_UPPER?	added																																																																									
CONF:NST:MFG:POW_CRITERIA_LOWER	added																																																																									
READ:NST:MFG:POW_CRITERIA_LOWER?	added																																																																									
READ:NST:MFG:PER?	added																																																																									
READ:NST:MFG:POW?	added																																																																									
READ:NST:MFG:STATUS?	added																																																																									
CONF:NST:MFG:TIME_OUT	added																																																																									
READ:NST:MFG:TIME_OUT?	added																																																																									
CONF:NST:MFG:MODE	added																																																																									
READ:NST:MFG:MODE?	added																																																																									
CONF:NST:MFG:INTERVAL	added																																																																									
READ:NST:MFG:INTERVAL?	added																																																																									
CONF:NST:MFG:BW	added																																																																									
READ:NST:MFG:BW?	added																																																																									
CONF:NST:MFG:SF	added																																																																									
READ:NST:MFG:SF?	added																																																																									
CONF:NST:MFG:CR	added																																																																									
READ:NST:MFG:CR?	added																																																																									
CONF:NST:MFG:PAYLOAD_SIZE	added																																																																									
READ:NST:MFG:PAYLOAD_SIZE?	added																																																																									
CONF:NST:MFG:PAYLOAD_TYPE	added																																																																									
READ:NST:MFG:PAYLOAD_TYPE?	added																																																																									
CONF:NST:MFG:PREAMBLE_SIZE	added																																																																									
READ:NST:MFG:PREAMBLE_SIZE?	added																																																																									
EXEC:NST:MFG:RUN	added																																																																									
EXEC:NST:MFG:STOP	added																																																																									
CONF:NST:MFG:REPEAT_NUM	added																																																																									
READ:NST:MFG:REPEAT_NUM?	added																																																																									
CONF:NST:MFG:NETWORK	added																																																																									
READ:NST:MFG:NETWORK?	added																																																																									
READ:NST:MFG:DUT_INFO?	added																																																																									
V1.11	2018.03.19	<ul style="list-style-type: none"> - Firmware version: V1.11 - Updated all pictures according to FW V1.11 - Revised the usage of Signal Generator and Signal Analyzer in NST mode - Added protocol parameters to expand a function of test frame generation/analysis in NST mode - Added explanation about additional MAC commands for LoRaWAN V1.1 - Added or renamed remote commands. See 4.4 for details. <table border="1"> <tr> <td colspan="2">Commands for RF Parameters</td> </tr> <tr> <td>CONF:RF:UL_CH</td> <td>Added For EDT, n=3 (EU868, IN865) or n=4 (KR922, AS923, EU433) For GWT, all channel frequencies are editable.</td> </tr> <tr> <td colspan="2">Commands for PROTOCOL Parameters</td> </tr> <tr> <td>CONF:PROTOCOL:MESSAGE_TYEP</td> <td>Added</td> </tr> <tr> <td>READ:PROTOCOL:MESSAGE_TYEP?</td> <td>Added</td> </tr> <tr> <td>CONF:PROTOCOL:MAC_FORMAT</td> <td>Added</td> </tr> <tr> <td>READ:PROTOCOL:MAC_FORMAT?</td> <td>Added</td> </tr> <tr> <td>CONF:PROTOCOL:FCNT</td> <td>Added</td> </tr> <tr> <td>READ:PROTOCOL:FCNT?</td> <td>Added</td> </tr> <tr> <td>CONF:PROTOCOL:FCNT_MODE</td> <td>Added</td> </tr> <tr> <td>READ:PROTOCOL:FCNT_MODE?</td> <td>Added</td> </tr> <tr> <td>CONF:PROTOCOL:ADR_ACK_REQ</td> <td>Added</td> </tr> <tr> <td>READ:PROTOCOL:ADR_ACK_REQ?</td> <td>Added</td> </tr> <tr> <td>CONF:PROTOCOL:ACK</td> <td>Added</td> </tr> <tr> <td>READ:PROTOCOL:ACK?</td> <td>Added</td> </tr> <tr> <td>CONF:PROTOCOL:FPENDING</td> <td>Added</td> </tr> </table>	Commands for RF Parameters		CONF:RF:UL_CH	Added For EDT, n=3 (EU868, IN865) or n=4 (KR922, AS923, EU433) For GWT, all channel frequencies are editable.	Commands for PROTOCOL Parameters		CONF:PROTOCOL:MESSAGE_TYEP	Added	READ:PROTOCOL:MESSAGE_TYEP?	Added	CONF:PROTOCOL:MAC_FORMAT	Added	READ:PROTOCOL:MAC_FORMAT?	Added	CONF:PROTOCOL:FCNT	Added	READ:PROTOCOL:FCNT?	Added	CONF:PROTOCOL:FCNT_MODE	Added	READ:PROTOCOL:FCNT_MODE?	Added	CONF:PROTOCOL:ADR_ACK_REQ	Added	READ:PROTOCOL:ADR_ACK_REQ?	Added	CONF:PROTOCOL:ACK	Added	READ:PROTOCOL:ACK?	Added	CONF:PROTOCOL:FPENDING	Added																																								
Commands for RF Parameters																																																																										
CONF:RF:UL_CH	Added For EDT, n=3 (EU868, IN865) or n=4 (KR922, AS923, EU433) For GWT, all channel frequencies are editable.																																																																									
Commands for PROTOCOL Parameters																																																																										
CONF:PROTOCOL:MESSAGE_TYEP	Added																																																																									
READ:PROTOCOL:MESSAGE_TYEP?	Added																																																																									
CONF:PROTOCOL:MAC_FORMAT	Added																																																																									
READ:PROTOCOL:MAC_FORMAT?	Added																																																																									
CONF:PROTOCOL:FCNT	Added																																																																									
READ:PROTOCOL:FCNT?	Added																																																																									
CONF:PROTOCOL:FCNT_MODE	Added																																																																									
READ:PROTOCOL:FCNT_MODE?	Added																																																																									
CONF:PROTOCOL:ADR_ACK_REQ	Added																																																																									
READ:PROTOCOL:ADR_ACK_REQ?	Added																																																																									
CONF:PROTOCOL:ACK	Added																																																																									
READ:PROTOCOL:ACK?	Added																																																																									
CONF:PROTOCOL:FPENDING	Added																																																																									

		READ:PROTOCOL:FPENDING?	Added																																																														
V1.10	2017.12.27	<p>- Firmware version: V1.10</p> <p>- Added a section of Usage of Link Analyzer for Class B EDT</p> <p>- Added a section of Usage of Link Analyzer for Class B GWT</p> <p>- Updated activation procedures for LoRaWAN V1.1</p> <p>- Class B support (V1.0.2classB draft4 and V1.1)</p> <p>- LoRaWAN V1.1 support</p> <p>- Added or renamed remote commands. See 4.4 for details.</p> <table border="1"> <thead> <tr> <th colspan="2">Commands for RF Parameters</th> </tr> </thead> <tbody> <tr> <td>READ:RF:UL_CH?</td> <td>added (n=0,1,...,7)</td> </tr> <tr> <td>READ:RF:DL_CH?</td> <td>added (n=0,1,...,7)</td> </tr> <tr> <th colspan="2">Commands for Protocol Parameter</th> </tr> <tr> <td>CONF:PROTOCOL:DOWNLINK_SLOT READ:PROTOCOL:DOWNLINK_SLOT?</td> <td>renamed from ...RX_WINDOW renamed from ...RX_WINDOW?</td> </tr> <tr> <td>CONF:PROTOCOL:NETWORK READ:PROTOCOL:NETWORK?</td> <td>renamed from ...SYNC_WORD renamed from ...SYNC_WORD?</td> </tr> <tr> <td>CONF:PROTOCOL:UPLINK_DR READ:PROTOCOL:UPLINK_DR?</td> <td>renamed from ...UL_DR renamed from ...UL_DR?</td> </tr> <tr> <td>CONF:PROTOCOL:UPDATE_FCNT READ:PROTOCOL:UPDATE_FCNT?</td> <td>added added</td> </tr> <tr> <td>CONF:PROTOCOL:PING_PERIODICITY READ:PROTOCOL:PING_PERIODICITY?</td> <td>added added</td> </tr> <tr> <td>CONF:PROTOCOL:PROTOCOL_VER READ:PROTOCOL:PROTOCOL_VER?</td> <td>added added</td> </tr> <tr> <td>CONF:PROTOCOL:NWK_KEY READ:PROTOCOL:NWK_KEY?</td> <td>added (for LoRaWAN V1.1) added (for LoRaWAN V1.1)</td> </tr> <tr> <td>CONF:PROTOCOL:FNWKS_IKEY READ:PROTOCOL:FNWKS_IKEY?</td> <td>added (for LoRaWAN V1.1) added (for LoRaWAN V1.1)</td> </tr> <tr> <td>CONF:PROTOCOL:SNWKS_IKEY READ:PROTOCOL:SNWKS_IKEY?</td> <td>added (for LoRaWAN V1.1) added (for LoRaWAN V1.1)</td> </tr> <tr> <td>CONF:PROTOCOL:NWKS_EKEY READ:PROTOCOL:NWKS_EKEY?</td> <td>added (for LoRaWAN V1.1) added (for LoRaWAN V1.1)</td> </tr> <tr> <td>READ:PROTOCOL:DL_DWELL_TIME?</td> <td>added</td> </tr> <tr> <td>READ:PROTOCOL:UL_DWELL_TIME?</td> <td>added</td> </tr> <tr> <td>CONF:PROTOCOL:LATITUDE READ:PROTOCOL:LATITUDE?</td> <td>added added</td> </tr> <tr> <td>CONF:PROTOCOL:LONGITUDE READ:PROTOCOL:LONGITUDE?</td> <td>added added</td> </tr> <tr> <td>CONF:PROTOCOL:UPDATE_NFCNT READ:PROTOCOL:UPDATE_NFCNT?</td> <td>added (for LoRaWAN V1.1) added (for LoRaWAN V1.1)</td> </tr> <tr> <td>CONF:PROTOCOL:UPDATE_AFCNT READ:PROTOCOL:UPDATE_AFCNT?</td> <td>added (for LoRaWAN V1.1) added (for LoRaWAN V1.1)</td> </tr> <tr> <td>CONF:PROTOCOL:JOIN_EUI READ:PROTOCOL:JOIN_EUI?</td> <td>added (for LoRaWAN V1.1) added (for LoRaWAN V1.1)</td> </tr> <tr> <th colspan="2">Commands for LINK</th> </tr> <tr> <td>CONF:LINK:MIC_ERR_DISPLAY READ:LINK:MIC_ERR_DISPLAY?</td> <td>added added</td> </tr> <tr> <td>CONF:LINK:SET_TM_AT_OTAA READ:LINK:SET_TM_AT_OTAA?</td> <td>added added</td> </tr> <tr> <td>CONF:LINK:SET_CH_AT_OTAA READ:LINK:SET_CH_AT_OTAA?</td> <td>added added</td> </tr> <tr> <td>CONF:LINK:REJOIN_DR READ:LINK:REJOIN_DR?</td> <td>added (for LoRaWAN V1.1) added (for LoRaWAN V1.1)</td> </tr> <tr> <td>CONF:LINK:REJOIN_TYPE READ:LINK:REJOIN_TYPE?</td> <td>added (for LoRaWAN V1.1) added (for LoRaWAN V1.1)</td> </tr> <tr> <td>CONF:LINK:REJOIN_RETRY READ:LINK:REJOIN_RETRY?</td> <td>added (for LoRaWAN V1.1) added (for LoRaWAN V1.1)</td> </tr> <tr> <td>CONF:LINK:REJOIN_PERIOD READ:LINK:REJOIN_PERIOD?</td> <td>added (for LoRaWAN V1.1) added (for LoRaWAN V1.1)</td> </tr> <tr> <td>CONF:LINK:REJOIN_MAX_TIME_N READ:LINK:REJOIN_MAX_TIME_N?</td> <td>added (for LoRaWAN V1.1) added (for LoRaWAN V1.1)</td> </tr> <tr> <td>CONF:LINK:REJOIN_MAX_CNT N</td> <td>added (for LoRaWAN V1.1)</td> </tr> </tbody> </table>		Commands for RF Parameters		READ:RF:UL_CH?	added (n=0,1,...,7)	READ:RF:DL_CH?	added (n=0,1,...,7)	Commands for Protocol Parameter		CONF:PROTOCOL:DOWNLINK_SLOT READ:PROTOCOL:DOWNLINK_SLOT?	renamed from ...RX_WINDOW renamed from ...RX_WINDOW?	CONF:PROTOCOL:NETWORK READ:PROTOCOL:NETWORK?	renamed from ...SYNC_WORD renamed from ...SYNC_WORD?	CONF:PROTOCOL:UPLINK_DR READ:PROTOCOL:UPLINK_DR?	renamed from ...UL_DR renamed from ...UL_DR?	CONF:PROTOCOL:UPDATE_FCNT READ:PROTOCOL:UPDATE_FCNT?	added added	CONF:PROTOCOL:PING_PERIODICITY READ:PROTOCOL:PING_PERIODICITY?	added added	CONF:PROTOCOL:PROTOCOL_VER READ:PROTOCOL:PROTOCOL_VER?	added added	CONF:PROTOCOL:NWK_KEY READ:PROTOCOL:NWK_KEY?	added (for LoRaWAN V1.1) added (for LoRaWAN V1.1)	CONF:PROTOCOL:FNWKS_IKEY READ:PROTOCOL:FNWKS_IKEY?	added (for LoRaWAN V1.1) added (for LoRaWAN V1.1)	CONF:PROTOCOL:SNWKS_IKEY READ:PROTOCOL:SNWKS_IKEY?	added (for LoRaWAN V1.1) added (for LoRaWAN V1.1)	CONF:PROTOCOL:NWKS_EKEY READ:PROTOCOL:NWKS_EKEY?	added (for LoRaWAN V1.1) added (for LoRaWAN V1.1)	READ:PROTOCOL:DL_DWELL_TIME?	added	READ:PROTOCOL:UL_DWELL_TIME?	added	CONF:PROTOCOL:LATITUDE READ:PROTOCOL:LATITUDE?	added added	CONF:PROTOCOL:LONGITUDE READ:PROTOCOL:LONGITUDE?	added added	CONF:PROTOCOL:UPDATE_NFCNT READ:PROTOCOL:UPDATE_NFCNT?	added (for LoRaWAN V1.1) added (for LoRaWAN V1.1)	CONF:PROTOCOL:UPDATE_AFCNT READ:PROTOCOL:UPDATE_AFCNT?	added (for LoRaWAN V1.1) added (for LoRaWAN V1.1)	CONF:PROTOCOL:JOIN_EUI READ:PROTOCOL:JOIN_EUI?	added (for LoRaWAN V1.1) added (for LoRaWAN V1.1)	Commands for LINK		CONF:LINK:MIC_ERR_DISPLAY READ:LINK:MIC_ERR_DISPLAY?	added added	CONF:LINK:SET_TM_AT_OTAA READ:LINK:SET_TM_AT_OTAA?	added added	CONF:LINK:SET_CH_AT_OTAA READ:LINK:SET_CH_AT_OTAA?	added added	CONF:LINK:REJOIN_DR READ:LINK:REJOIN_DR?	added (for LoRaWAN V1.1) added (for LoRaWAN V1.1)	CONF:LINK:REJOIN_TYPE READ:LINK:REJOIN_TYPE?	added (for LoRaWAN V1.1) added (for LoRaWAN V1.1)	CONF:LINK:REJOIN_RETRY READ:LINK:REJOIN_RETRY?	added (for LoRaWAN V1.1) added (for LoRaWAN V1.1)	CONF:LINK:REJOIN_PERIOD READ:LINK:REJOIN_PERIOD?	added (for LoRaWAN V1.1) added (for LoRaWAN V1.1)	CONF:LINK:REJOIN_MAX_TIME_N READ:LINK:REJOIN_MAX_TIME_N?	added (for LoRaWAN V1.1) added (for LoRaWAN V1.1)	CONF:LINK:REJOIN_MAX_CNT N	added (for LoRaWAN V1.1)
Commands for RF Parameters																																																																	
READ:RF:UL_CH?	added (n=0,1,...,7)																																																																
READ:RF:DL_CH?	added (n=0,1,...,7)																																																																
Commands for Protocol Parameter																																																																	
CONF:PROTOCOL:DOWNLINK_SLOT READ:PROTOCOL:DOWNLINK_SLOT?	renamed from ...RX_WINDOW renamed from ...RX_WINDOW?																																																																
CONF:PROTOCOL:NETWORK READ:PROTOCOL:NETWORK?	renamed from ...SYNC_WORD renamed from ...SYNC_WORD?																																																																
CONF:PROTOCOL:UPLINK_DR READ:PROTOCOL:UPLINK_DR?	renamed from ...UL_DR renamed from ...UL_DR?																																																																
CONF:PROTOCOL:UPDATE_FCNT READ:PROTOCOL:UPDATE_FCNT?	added added																																																																
CONF:PROTOCOL:PING_PERIODICITY READ:PROTOCOL:PING_PERIODICITY?	added added																																																																
CONF:PROTOCOL:PROTOCOL_VER READ:PROTOCOL:PROTOCOL_VER?	added added																																																																
CONF:PROTOCOL:NWK_KEY READ:PROTOCOL:NWK_KEY?	added (for LoRaWAN V1.1) added (for LoRaWAN V1.1)																																																																
CONF:PROTOCOL:FNWKS_IKEY READ:PROTOCOL:FNWKS_IKEY?	added (for LoRaWAN V1.1) added (for LoRaWAN V1.1)																																																																
CONF:PROTOCOL:SNWKS_IKEY READ:PROTOCOL:SNWKS_IKEY?	added (for LoRaWAN V1.1) added (for LoRaWAN V1.1)																																																																
CONF:PROTOCOL:NWKS_EKEY READ:PROTOCOL:NWKS_EKEY?	added (for LoRaWAN V1.1) added (for LoRaWAN V1.1)																																																																
READ:PROTOCOL:DL_DWELL_TIME?	added																																																																
READ:PROTOCOL:UL_DWELL_TIME?	added																																																																
CONF:PROTOCOL:LATITUDE READ:PROTOCOL:LATITUDE?	added added																																																																
CONF:PROTOCOL:LONGITUDE READ:PROTOCOL:LONGITUDE?	added added																																																																
CONF:PROTOCOL:UPDATE_NFCNT READ:PROTOCOL:UPDATE_NFCNT?	added (for LoRaWAN V1.1) added (for LoRaWAN V1.1)																																																																
CONF:PROTOCOL:UPDATE_AFCNT READ:PROTOCOL:UPDATE_AFCNT?	added (for LoRaWAN V1.1) added (for LoRaWAN V1.1)																																																																
CONF:PROTOCOL:JOIN_EUI READ:PROTOCOL:JOIN_EUI?	added (for LoRaWAN V1.1) added (for LoRaWAN V1.1)																																																																
Commands for LINK																																																																	
CONF:LINK:MIC_ERR_DISPLAY READ:LINK:MIC_ERR_DISPLAY?	added added																																																																
CONF:LINK:SET_TM_AT_OTAA READ:LINK:SET_TM_AT_OTAA?	added added																																																																
CONF:LINK:SET_CH_AT_OTAA READ:LINK:SET_CH_AT_OTAA?	added added																																																																
CONF:LINK:REJOIN_DR READ:LINK:REJOIN_DR?	added (for LoRaWAN V1.1) added (for LoRaWAN V1.1)																																																																
CONF:LINK:REJOIN_TYPE READ:LINK:REJOIN_TYPE?	added (for LoRaWAN V1.1) added (for LoRaWAN V1.1)																																																																
CONF:LINK:REJOIN_RETRY READ:LINK:REJOIN_RETRY?	added (for LoRaWAN V1.1) added (for LoRaWAN V1.1)																																																																
CONF:LINK:REJOIN_PERIOD READ:LINK:REJOIN_PERIOD?	added (for LoRaWAN V1.1) added (for LoRaWAN V1.1)																																																																
CONF:LINK:REJOIN_MAX_TIME_N READ:LINK:REJOIN_MAX_TIME_N?	added (for LoRaWAN V1.1) added (for LoRaWAN V1.1)																																																																
CONF:LINK:REJOIN_MAX_CNT N	added (for LoRaWAN V1.1)																																																																

		<table border="1"> <tr><td>READ:LINK:REJOIN_MAX_CNT_N?</td><td>added (for LoRaWAN V1.1)</td></tr> <tr><td>CONF:LINK:ADR_LIMIT_EXP</td><td>added (for LoRaWAN V1.1)</td></tr> <tr><td>READ:LINK:ADR_LIMIT_EXP?</td><td>added (for LoRaWAN V1.1)</td></tr> <tr><td>CONF:LINK:ADR_DELAY_EXP</td><td>added (for LoRaWAN V1.1)</td></tr> <tr><td>READ:LINK:ADR_DELAY_EXP?</td><td>added (for LoRaWAN V1.1)</td></tr> <tr><td>CONF:LINK:PING_FREQ</td><td>added</td></tr> <tr><td>READ:LINK:PING_FREQ?</td><td>added</td></tr> <tr><td>CONF:LINK:PING_DR</td><td>added</td></tr> <tr><td>READ:LINK:PING_DR?</td><td>added</td></tr> <tr><td>CONF:LINK:BEACON_FREQ</td><td>added</td></tr> <tr><td>READ:LINK:BEACON_FREQ?</td><td>added</td></tr> <tr><td>CONF:LINK:BEACON_DR</td><td>added</td></tr> <tr><td>READ:LINK:BEACON_DR?</td><td>added</td></tr> <tr><td colspan="2">Commands for SENSITIVITY</td></tr> <tr><td>CONF:SENSITIVITY:DOWNLINK_SLOT</td><td>renamed from ...RX_WINDOW</td></tr> <tr><td>READ:SENSITIVITY:DOWNLINK_SLOT?</td><td>renamed from ...RX_WINDOW?</td></tr> <tr><td colspan="2">Commands for NST</td></tr> <tr><td>CONF:NST:TX:NETWORK</td><td>renamed from ...SYNC_WORD</td></tr> <tr><td>READ:NST:TX:NETWORK?</td><td>renamed from ...SYNC_WORD?</td></tr> <tr><td>CONF:NST:RX:NETWORK</td><td>renamed from ...SYNC_WORD</td></tr> <tr><td>READ:NST:RX:NETWORK?</td><td>renamed from ...SYNC_WORD?</td></tr> <tr><td>CONF:NST:TX:IQ_POLARITY</td><td>deleted</td></tr> <tr><td>READ:NST:TX:IQ_POLARITY?</td><td>deleted</td></tr> <tr><td>CONF:NST:RX:IQ_POLARITY</td><td>deleted</td></tr> <tr><td>READ:NST:RX:IQ_POLARITY?</td><td>deleted</td></tr> </table>	READ:LINK:REJOIN_MAX_CNT_N?	added (for LoRaWAN V1.1)	CONF:LINK:ADR_LIMIT_EXP	added (for LoRaWAN V1.1)	READ:LINK:ADR_LIMIT_EXP?	added (for LoRaWAN V1.1)	CONF:LINK:ADR_DELAY_EXP	added (for LoRaWAN V1.1)	READ:LINK:ADR_DELAY_EXP?	added (for LoRaWAN V1.1)	CONF:LINK:PING_FREQ	added	READ:LINK:PING_FREQ?	added	CONF:LINK:PING_DR	added	READ:LINK:PING_DR?	added	CONF:LINK:BEACON_FREQ	added	READ:LINK:BEACON_FREQ?	added	CONF:LINK:BEACON_DR	added	READ:LINK:BEACON_DR?	added	Commands for SENSITIVITY		CONF:SENSITIVITY:DOWNLINK_SLOT	renamed from ...RX_WINDOW	READ:SENSITIVITY:DOWNLINK_SLOT?	renamed from ...RX_WINDOW?	Commands for NST		CONF:NST:TX:NETWORK	renamed from ...SYNC_WORD	READ:NST:TX:NETWORK?	renamed from ...SYNC_WORD?	CONF:NST:RX:NETWORK	renamed from ...SYNC_WORD	READ:NST:RX:NETWORK?	renamed from ...SYNC_WORD?	CONF:NST:TX:IQ_POLARITY	deleted	READ:NST:TX:IQ_POLARITY?	deleted	CONF:NST:RX:IQ_POLARITY	deleted	READ:NST:RX:IQ_POLARITY?	deleted																						
READ:LINK:REJOIN_MAX_CNT_N?	added (for LoRaWAN V1.1)																																																																									
CONF:LINK:ADR_LIMIT_EXP	added (for LoRaWAN V1.1)																																																																									
READ:LINK:ADR_LIMIT_EXP?	added (for LoRaWAN V1.1)																																																																									
CONF:LINK:ADR_DELAY_EXP	added (for LoRaWAN V1.1)																																																																									
READ:LINK:ADR_DELAY_EXP?	added (for LoRaWAN V1.1)																																																																									
CONF:LINK:PING_FREQ	added																																																																									
READ:LINK:PING_FREQ?	added																																																																									
CONF:LINK:PING_DR	added																																																																									
READ:LINK:PING_DR?	added																																																																									
CONF:LINK:BEACON_FREQ	added																																																																									
READ:LINK:BEACON_FREQ?	added																																																																									
CONF:LINK:BEACON_DR	added																																																																									
READ:LINK:BEACON_DR?	added																																																																									
Commands for SENSITIVITY																																																																										
CONF:SENSITIVITY:DOWNLINK_SLOT	renamed from ...RX_WINDOW																																																																									
READ:SENSITIVITY:DOWNLINK_SLOT?	renamed from ...RX_WINDOW?																																																																									
Commands for NST																																																																										
CONF:NST:TX:NETWORK	renamed from ...SYNC_WORD																																																																									
READ:NST:TX:NETWORK?	renamed from ...SYNC_WORD?																																																																									
CONF:NST:RX:NETWORK	renamed from ...SYNC_WORD																																																																									
READ:NST:RX:NETWORK?	renamed from ...SYNC_WORD?																																																																									
CONF:NST:TX:IQ_POLARITY	deleted																																																																									
READ:NST:TX:IQ_POLARITY?	deleted																																																																									
CONF:NST:RX:IQ_POLARITY	deleted																																																																									
READ:NST:RX:IQ_POLARITY?	deleted																																																																									
V1.05	2017.09.26	<p>- Firmware version: V1.05 - Added or renamed remote commands. See 4.4 for details.</p> <table border="1"> <tr><td colspan="2">Commands for RF Parameters</td></tr> <tr><td>CONF:RF:FREQ_OFFSET</td><td>added</td></tr> <tr><td>READ:RF:FREQ_OFFSET?</td><td>added</td></tr> <tr><td>CONF:RF:TIME_OFFSET</td><td></td></tr> <tr><td>READ:RF:TIME_OFFSET?</td><td></td></tr> <tr><td>CONF:RF:CH_MASK_n</td><td>added (n=0,1,...,5)</td></tr> <tr><td>READ:RF:CH_MASK_n?</td><td>added</td></tr> <tr><td>CONF:RF:CH_GROUP_A</td><td>added</td></tr> <tr><td>READ:RF:CH_GROUP_A?</td><td>added</td></tr> <tr><td>CONF:RF:CH_GROUP_B</td><td>added</td></tr> <tr><td>READ:RF:CH_GROUP_B?</td><td>added</td></tr> <tr><td>CONF:RF:CH_n</td><td>deleted (n=0,1,...,7)</td></tr> <tr><td>READ:RF:CH_n?</td><td>deleted</td></tr> <tr><td>CONF:RF:UL_CH_n</td><td>deleted (n=0,1,...,7)</td></tr> <tr><td>READ:RF:UL_CH_n?</td><td>deleted</td></tr> <tr><td>CONF:RF:DL_CH_n</td><td>deleted (n=0,1,...,7)</td></tr> <tr><td>READ:RF:DL_CH_n?</td><td>deleted</td></tr> <tr><td colspan="2">Commands for Protocol Parameter</td></tr> <tr><td>CONF:PROTOCOL:RX_WINDOW</td><td>renamed from CONF:RF:RX_WINDOW</td></tr> <tr><td>READ:PROTOCOL:RX_WINDOW?</td><td>renamed from READ:RF:RX_WINDOW?</td></tr> <tr><td>CONF:PROTOCOL:RX1_DR_OFFSET</td><td>renamed from CONF:LINK:RX1_DR_OFFSET</td></tr> <tr><td>READ:PROTOCOL:RX1_DR_OFFSET?</td><td>renamed from READ:LINK:RX1_DR_OFFSET?</td></tr> <tr><td>CONF:PROTOCOL:RX2_FREQ</td><td>renamed from CONF:LINK:RX2_FREQ</td></tr> <tr><td>READ:PROTOCOL:RX2_FREQ?</td><td>renamed from READ:LINK:RX2_FREQ?</td></tr> <tr><td>CONF:PROTOCOL:RX2_DR</td><td>renamed from CONF:LINK:RX2_DR</td></tr> <tr><td>READ:PROTOCOL:RX2_DR?</td><td>renamed from READ:LINK:RX2_DR?</td></tr> <tr><td>CONF:PROTOCOL:UL_DR</td><td>renamed from CONF:RF:UL_DR</td></tr> <tr><td>READ:PROTOCOL:UL_DR?</td><td>renamed from READ:RF:UL_DR?</td></tr> <tr><td colspan="2">Commands for LINK</td></tr> <tr><td>CONF:LINK:MAC_CMD_TYPE</td><td>added</td></tr> <tr><td>READ:LINK:MAC_CMD_TYPE?</td><td>added</td></tr> <tr><td>CONF:LINK:MAC_CMD_FIELD</td><td>added</td></tr> <tr><td>READ:LINK:MAC_CMD_FIELD?</td><td>added</td></tr> <tr><td>CONF:LINK:NUM_OF_CMD</td><td>added</td></tr> <tr><td>READ:LINK:NUM_OF_CMD?</td><td>added</td></tr> <tr><td>CONF:LINK:DL_CH_INDEX</td><td>added</td></tr> </table>	Commands for RF Parameters		CONF:RF:FREQ_OFFSET	added	READ:RF:FREQ_OFFSET?	added	CONF:RF:TIME_OFFSET		READ:RF:TIME_OFFSET?		CONF:RF:CH_MASK_n	added (n=0,1,...,5)	READ:RF:CH_MASK_n?	added	CONF:RF:CH_GROUP_A	added	READ:RF:CH_GROUP_A?	added	CONF:RF:CH_GROUP_B	added	READ:RF:CH_GROUP_B?	added	CONF:RF:CH_n	deleted (n=0,1,...,7)	READ:RF:CH_n?	deleted	CONF:RF:UL_CH_n	deleted (n=0,1,...,7)	READ:RF:UL_CH_n?	deleted	CONF:RF:DL_CH_n	deleted (n=0,1,...,7)	READ:RF:DL_CH_n?	deleted	Commands for Protocol Parameter		CONF:PROTOCOL:RX_WINDOW	renamed from CONF:RF:RX_WINDOW	READ:PROTOCOL:RX_WINDOW?	renamed from READ:RF:RX_WINDOW?	CONF:PROTOCOL:RX1_DR_OFFSET	renamed from CONF:LINK:RX1_DR_OFFSET	READ:PROTOCOL:RX1_DR_OFFSET?	renamed from READ:LINK:RX1_DR_OFFSET?	CONF:PROTOCOL:RX2_FREQ	renamed from CONF:LINK:RX2_FREQ	READ:PROTOCOL:RX2_FREQ?	renamed from READ:LINK:RX2_FREQ?	CONF:PROTOCOL:RX2_DR	renamed from CONF:LINK:RX2_DR	READ:PROTOCOL:RX2_DR?	renamed from READ:LINK:RX2_DR?	CONF:PROTOCOL:UL_DR	renamed from CONF:RF:UL_DR	READ:PROTOCOL:UL_DR?	renamed from READ:RF:UL_DR?	Commands for LINK		CONF:LINK:MAC_CMD_TYPE	added	READ:LINK:MAC_CMD_TYPE?	added	CONF:LINK:MAC_CMD_FIELD	added	READ:LINK:MAC_CMD_FIELD?	added	CONF:LINK:NUM_OF_CMD	added	READ:LINK:NUM_OF_CMD?	added	CONF:LINK:DL_CH_INDEX	added
Commands for RF Parameters																																																																										
CONF:RF:FREQ_OFFSET	added																																																																									
READ:RF:FREQ_OFFSET?	added																																																																									
CONF:RF:TIME_OFFSET																																																																										
READ:RF:TIME_OFFSET?																																																																										
CONF:RF:CH_MASK_n	added (n=0,1,...,5)																																																																									
READ:RF:CH_MASK_n?	added																																																																									
CONF:RF:CH_GROUP_A	added																																																																									
READ:RF:CH_GROUP_A?	added																																																																									
CONF:RF:CH_GROUP_B	added																																																																									
READ:RF:CH_GROUP_B?	added																																																																									
CONF:RF:CH_n	deleted (n=0,1,...,7)																																																																									
READ:RF:CH_n?	deleted																																																																									
CONF:RF:UL_CH_n	deleted (n=0,1,...,7)																																																																									
READ:RF:UL_CH_n?	deleted																																																																									
CONF:RF:DL_CH_n	deleted (n=0,1,...,7)																																																																									
READ:RF:DL_CH_n?	deleted																																																																									
Commands for Protocol Parameter																																																																										
CONF:PROTOCOL:RX_WINDOW	renamed from CONF:RF:RX_WINDOW																																																																									
READ:PROTOCOL:RX_WINDOW?	renamed from READ:RF:RX_WINDOW?																																																																									
CONF:PROTOCOL:RX1_DR_OFFSET	renamed from CONF:LINK:RX1_DR_OFFSET																																																																									
READ:PROTOCOL:RX1_DR_OFFSET?	renamed from READ:LINK:RX1_DR_OFFSET?																																																																									
CONF:PROTOCOL:RX2_FREQ	renamed from CONF:LINK:RX2_FREQ																																																																									
READ:PROTOCOL:RX2_FREQ?	renamed from READ:LINK:RX2_FREQ?																																																																									
CONF:PROTOCOL:RX2_DR	renamed from CONF:LINK:RX2_DR																																																																									
READ:PROTOCOL:RX2_DR?	renamed from READ:LINK:RX2_DR?																																																																									
CONF:PROTOCOL:UL_DR	renamed from CONF:RF:UL_DR																																																																									
READ:PROTOCOL:UL_DR?	renamed from READ:RF:UL_DR?																																																																									
Commands for LINK																																																																										
CONF:LINK:MAC_CMD_TYPE	added																																																																									
READ:LINK:MAC_CMD_TYPE?	added																																																																									
CONF:LINK:MAC_CMD_FIELD	added																																																																									
READ:LINK:MAC_CMD_FIELD?	added																																																																									
CONF:LINK:NUM_OF_CMD	added																																																																									
READ:LINK:NUM_OF_CMD?	added																																																																									
CONF:LINK:DL_CH_INDEX	added																																																																									

		<table border="1"> <tr><td>READ:LINK:DL_CH_INDEX?</td><td>added</td></tr> <tr><td>CONF:LINK:DL_CH_FREQ</td><td>added</td></tr> <tr><td>READ:LINK:DL_CH_FREQ?</td><td>added</td></tr> <tr><td colspan="2">Commands for POW_TIME & POW_CH</td></tr> <tr><td>READ:POWER:ALL:NUM?</td><td>added</td></tr> <tr><td>READ:POWER:SF7:NUM?</td><td>added</td></tr> <tr><td>READ:POWER:SF8:NUM?</td><td>added</td></tr> <tr><td>READ:POWER:SF9:NUM?</td><td>added</td></tr> <tr><td>READ:POWER:SF10:NUM?</td><td>added</td></tr> <tr><td>READ:POWER:SF11:NUM?</td><td>added</td></tr> <tr><td>READ:POWER:SF12:NUM?</td><td>added</td></tr> <tr><td>READ:POWER:CH_0:NUM?</td><td>added</td></tr> <tr><td>READ:POWER:CH_1:NUM?</td><td>added</td></tr> <tr><td>READ:POWER:CH_2:NUM?</td><td>added</td></tr> <tr><td>READ:POWER:CH_3:NUM?</td><td>added</td></tr> <tr><td>READ:POWER:CH_4:NUM?</td><td>added</td></tr> <tr><td>READ:POWER:CH_5:NUM?</td><td>added</td></tr> <tr><td>READ:POWER:CH_6:NUM?</td><td>added</td></tr> <tr><td>READ:POWER:CH_7:NUM?</td><td>added</td></tr> <tr><td>READ:POWER:RX2:NUM?</td><td>added</td></tr> <tr><td>READ:POWER:RX2:MAX?</td><td>added</td></tr> <tr><td>READ:POWER:RX2:AVG?</td><td>added</td></tr> <tr><td>READ:POWER:RX2:MIN?</td><td>added</td></tr> <tr><td colspan="2">Commands for SENSITIVITY</td></tr> <tr><td>CONF:SENSITIVITY:NUM_POW</td><td>added</td></tr> <tr><td>READ:SENSITIVITY:NUM_POW?</td><td>added</td></tr> <tr><td>CONF:SENSITIVITY:STEP_NUM</td><td>deleted</td></tr> <tr><td>READ:SENSITIVITY:STEP_NUM?</td><td>deleted</td></tr> <tr><td>CONF:SENSITIVITY:SET_SF_AT_START</td><td>renamed from SET_DR_AT_START</td></tr> <tr><td>READ:SENSITIVITY:SET_SF_AT_START?</td><td>renamed from SET_DR_AT_START?</td></tr> <tr><td>CONF:SENSITIVITY:SF</td><td>renamed from CONF:SENSITIVITY:DR</td></tr> <tr><td>READ:SENSITIVITY:SF?</td><td>renamed from READ:SENSITIVITY:SF?</td></tr> <tr><td>CONF:SENSITIVITY:PAYLOAD_TYPE</td><td>added</td></tr> <tr><td>READ:SENSITIVITY:PAYLOAD_TYPE?</td><td>added</td></tr> <tr><td>CONF:SENSITIVITY:FPORT</td><td>added</td></tr> <tr><td>READ:SENSITIVITY:FPORT?</td><td>added</td></tr> <tr><td>CONF:SENSITIVITY:PAYLOAD_SIZE</td><td>added</td></tr> <tr><td>READ:SENSITIVITY:PAYLOAD_SIZE?</td><td>added</td></tr> <tr><td>CONF:SENSITIVITY:PAYLOAD</td><td>added</td></tr> <tr><td>READ:SENSITIVITY:PAYLOAD?</td><td>added</td></tr> <tr><td colspan="2">Commands for NST</td></tr> <tr><td>CONF:NST:TX:SYNC_WORD</td><td>added</td></tr> <tr><td>READ:NST:TX:SYNC_WORD?</td><td>added</td></tr> <tr><td>CONF:NST:RX:SYNC_WORD</td><td>added</td></tr> <tr><td>READ:NST:RX:SYNC_WORD?</td><td>added</td></tr> <tr><td>READ:NST:RX:POW_NUM?</td><td>added</td></tr> <tr><td>READ:NST:RX:POW_MAX?</td><td>added</td></tr> <tr><td>READ:NST:RX:POW_AVG?</td><td>added</td></tr> <tr><td>READ:NST:RX:POW_MIN?</td><td>added</td></tr> </table>	READ:LINK:DL_CH_INDEX?	added	CONF:LINK:DL_CH_FREQ	added	READ:LINK:DL_CH_FREQ?	added	Commands for POW_TIME & POW_CH		READ:POWER:ALL:NUM?	added	READ:POWER:SF7:NUM?	added	READ:POWER:SF8:NUM?	added	READ:POWER:SF9:NUM?	added	READ:POWER:SF10:NUM?	added	READ:POWER:SF11:NUM?	added	READ:POWER:SF12:NUM?	added	READ:POWER:CH_0:NUM?	added	READ:POWER:CH_1:NUM?	added	READ:POWER:CH_2:NUM?	added	READ:POWER:CH_3:NUM?	added	READ:POWER:CH_4:NUM?	added	READ:POWER:CH_5:NUM?	added	READ:POWER:CH_6:NUM?	added	READ:POWER:CH_7:NUM?	added	READ:POWER:RX2:NUM?	added	READ:POWER:RX2:MAX?	added	READ:POWER:RX2:AVG?	added	READ:POWER:RX2:MIN?	added	Commands for SENSITIVITY		CONF:SENSITIVITY:NUM_POW	added	READ:SENSITIVITY:NUM_POW?	added	CONF:SENSITIVITY:STEP_NUM	deleted	READ:SENSITIVITY:STEP_NUM?	deleted	CONF:SENSITIVITY:SET_SF_AT_START	renamed from SET_DR_AT_START	READ:SENSITIVITY:SET_SF_AT_START?	renamed from SET_DR_AT_START?	CONF:SENSITIVITY:SF	renamed from CONF:SENSITIVITY:DR	READ:SENSITIVITY:SF?	renamed from READ:SENSITIVITY:SF?	CONF:SENSITIVITY:PAYLOAD_TYPE	added	READ:SENSITIVITY:PAYLOAD_TYPE?	added	CONF:SENSITIVITY:FPORT	added	READ:SENSITIVITY:FPORT?	added	CONF:SENSITIVITY:PAYLOAD_SIZE	added	READ:SENSITIVITY:PAYLOAD_SIZE?	added	CONF:SENSITIVITY:PAYLOAD	added	READ:SENSITIVITY:PAYLOAD?	added	Commands for NST		CONF:NST:TX:SYNC_WORD	added	READ:NST:TX:SYNC_WORD?	added	CONF:NST:RX:SYNC_WORD	added	READ:NST:RX:SYNC_WORD?	added	READ:NST:RX:POW_NUM?	added	READ:NST:RX:POW_MAX?	added	READ:NST:RX:POW_AVG?	added	READ:NST:RX:POW_MIN?	added
READ:LINK:DL_CH_INDEX?	added																																																																																																			
CONF:LINK:DL_CH_FREQ	added																																																																																																			
READ:LINK:DL_CH_FREQ?	added																																																																																																			
Commands for POW_TIME & POW_CH																																																																																																				
READ:POWER:ALL:NUM?	added																																																																																																			
READ:POWER:SF7:NUM?	added																																																																																																			
READ:POWER:SF8:NUM?	added																																																																																																			
READ:POWER:SF9:NUM?	added																																																																																																			
READ:POWER:SF10:NUM?	added																																																																																																			
READ:POWER:SF11:NUM?	added																																																																																																			
READ:POWER:SF12:NUM?	added																																																																																																			
READ:POWER:CH_0:NUM?	added																																																																																																			
READ:POWER:CH_1:NUM?	added																																																																																																			
READ:POWER:CH_2:NUM?	added																																																																																																			
READ:POWER:CH_3:NUM?	added																																																																																																			
READ:POWER:CH_4:NUM?	added																																																																																																			
READ:POWER:CH_5:NUM?	added																																																																																																			
READ:POWER:CH_6:NUM?	added																																																																																																			
READ:POWER:CH_7:NUM?	added																																																																																																			
READ:POWER:RX2:NUM?	added																																																																																																			
READ:POWER:RX2:MAX?	added																																																																																																			
READ:POWER:RX2:AVG?	added																																																																																																			
READ:POWER:RX2:MIN?	added																																																																																																			
Commands for SENSITIVITY																																																																																																				
CONF:SENSITIVITY:NUM_POW	added																																																																																																			
READ:SENSITIVITY:NUM_POW?	added																																																																																																			
CONF:SENSITIVITY:STEP_NUM	deleted																																																																																																			
READ:SENSITIVITY:STEP_NUM?	deleted																																																																																																			
CONF:SENSITIVITY:SET_SF_AT_START	renamed from SET_DR_AT_START																																																																																																			
READ:SENSITIVITY:SET_SF_AT_START?	renamed from SET_DR_AT_START?																																																																																																			
CONF:SENSITIVITY:SF	renamed from CONF:SENSITIVITY:DR																																																																																																			
READ:SENSITIVITY:SF?	renamed from READ:SENSITIVITY:SF?																																																																																																			
CONF:SENSITIVITY:PAYLOAD_TYPE	added																																																																																																			
READ:SENSITIVITY:PAYLOAD_TYPE?	added																																																																																																			
CONF:SENSITIVITY:FPORT	added																																																																																																			
READ:SENSITIVITY:FPORT?	added																																																																																																			
CONF:SENSITIVITY:PAYLOAD_SIZE	added																																																																																																			
READ:SENSITIVITY:PAYLOAD_SIZE?	added																																																																																																			
CONF:SENSITIVITY:PAYLOAD	added																																																																																																			
READ:SENSITIVITY:PAYLOAD?	added																																																																																																			
Commands for NST																																																																																																				
CONF:NST:TX:SYNC_WORD	added																																																																																																			
READ:NST:TX:SYNC_WORD?	added																																																																																																			
CONF:NST:RX:SYNC_WORD	added																																																																																																			
READ:NST:RX:SYNC_WORD?	added																																																																																																			
READ:NST:RX:POW_NUM?	added																																																																																																			
READ:NST:RX:POW_MAX?	added																																																																																																			
READ:NST:RX:POW_AVG?	added																																																																																																			
READ:NST:RX:POW_MIN?	added																																																																																																			
V1.04	2017.08.05	<p>- Firmware version: V1.04</p> <p>- Improved Sensitivity Test in EDT by providing two different test scenarios: one is to use periodic uplink frames of DUT and the other is to use Echo request after DUT is activated to test mode.</p> <p>- Added or renamed remote commands corresponding to transmission of MAC commands. See 4.4.4 and 4.4.5.</p> <table border="1"> <tr><td>CONF:RF:RX_WINDOW</td><td>renamed from CONF:RF:DL_CH_OPTION</td></tr> <tr><td>READ:RF:RX_WINDOW?</td><td>renamed from READ:RF:DL_CH_OPTION?</td></tr> <tr><td>READ:PROTOCOL:ACTIVATION_STATUS?</td><td>added</td></tr> <tr><td>CONF:PROTOCOL:SYNC_WORD</td><td>added</td></tr> <tr><td>READ:PROTOCOL:SYNC_WORD?</td><td>added</td></tr> <tr><td>CONF:SENSITIVITY:SCENARIO</td><td>renamed from CONF:SENSITIVITY:MODE</td></tr> <tr><td>READ:SENSITIVITY:SCENARIO?</td><td>renamed from READ:SENSITIVITY:MODE?</td></tr> <tr><td>CONF:SENSITIVITY:PACKET_NUM</td><td>renamed from CONF:SENSITIVITY:REPEAT</td></tr> </table>	CONF:RF:RX_WINDOW	renamed from CONF:RF:DL_CH_OPTION	READ:RF:RX_WINDOW?	renamed from READ:RF:DL_CH_OPTION?	READ:PROTOCOL:ACTIVATION_STATUS?	added	CONF:PROTOCOL:SYNC_WORD	added	READ:PROTOCOL:SYNC_WORD?	added	CONF:SENSITIVITY:SCENARIO	renamed from CONF:SENSITIVITY:MODE	READ:SENSITIVITY:SCENARIO?	renamed from READ:SENSITIVITY:MODE?	CONF:SENSITIVITY:PACKET_NUM	renamed from CONF:SENSITIVITY:REPEAT																																																																																		
CONF:RF:RX_WINDOW	renamed from CONF:RF:DL_CH_OPTION																																																																																																			
READ:RF:RX_WINDOW?	renamed from READ:RF:DL_CH_OPTION?																																																																																																			
READ:PROTOCOL:ACTIVATION_STATUS?	added																																																																																																			
CONF:PROTOCOL:SYNC_WORD	added																																																																																																			
READ:PROTOCOL:SYNC_WORD?	added																																																																																																			
CONF:SENSITIVITY:SCENARIO	renamed from CONF:SENSITIVITY:MODE																																																																																																			
READ:SENSITIVITY:SCENARIO?	renamed from READ:SENSITIVITY:MODE?																																																																																																			
CONF:SENSITIVITY:PACKET_NUM	renamed from CONF:SENSITIVITY:REPEAT																																																																																																			

		<table border="1"> <tr> <td>READ:SENSITIVITY:PACKET_NUM?</td> <td>renamed from READ:SENSITIVITY:REPEAT?</td> </tr> <tr> <td>CONF:SENSITIVITY:RX_WINDOW</td> <td>added</td> </tr> <tr> <td>READ:SENSITIVITY:RX_WINDOW?</td> <td>added</td> </tr> <tr> <td>CONF:SENSITIVITY:DR</td> <td>added</td> </tr> <tr> <td>READ:SENSITIVITY:DR?</td> <td>added</td> </tr> <tr> <td>CONF:SENSITIVITY:SET_DR_AT_START</td> <td>added</td> </tr> <tr> <td>READ:SENSITIVITY:SET_DR_AT_START?</td> <td>added</td> </tr> <tr> <td>EXEC:NST:TX:RUN</td> <td>added</td> </tr> <tr> <td>EXEC:NST:TX:STOP</td> <td>added</td> </tr> <tr> <td>CONF:NST:TX:REPEAT_NUM</td> <td>added</td> </tr> <tr> <td>READ:NST:TX:REPEAT_NUM?</td> <td>added</td> </tr> <tr> <td>CONF:NST:TX:PAYLOAD</td> <td>added</td> </tr> <tr> <td>READ:NST:TX:PAYLOAD?</td> <td>added</td> </tr> <tr> <td>CONF:NST:TX:IQ_POLARITY</td> <td>added</td> </tr> <tr> <td>READ:NST:TX:IQ_POLARITY?</td> <td>added</td> </tr> <tr> <td>EXEC:NST:RX:RUN</td> <td>added</td> </tr> <tr> <td>EXEC:NST:RX:STOP</td> <td>added</td> </tr> <tr> <td>CONF:NST:RX:MODE</td> <td>added</td> </tr> <tr> <td>READ:NST:RX:MODE?</td> <td>added</td> </tr> <tr> <td>CONF:NST:RX:BW</td> <td>added</td> </tr> <tr> <td>READ:NST:RX:BW?</td> <td>added</td> </tr> <tr> <td>CONF:NST:RX:SF</td> <td>added</td> </tr> <tr> <td>READ:NST:RX:SF?</td> <td>added</td> </tr> <tr> <td>CONF:NST:RX:IQ_POLARITY</td> <td>added</td> </tr> <tr> <td>READ:NST:RX:IQ_POLARITY?</td> <td>added</td> </tr> <tr> <td colspan="2">All remote commands as to transmission of MAC commands were moved/renamed from PROTOCOL to LINK</td> </tr> </table>	READ:SENSITIVITY:PACKET_NUM?	renamed from READ:SENSITIVITY:REPEAT?	CONF:SENSITIVITY:RX_WINDOW	added	READ:SENSITIVITY:RX_WINDOW?	added	CONF:SENSITIVITY:DR	added	READ:SENSITIVITY:DR?	added	CONF:SENSITIVITY:SET_DR_AT_START	added	READ:SENSITIVITY:SET_DR_AT_START?	added	EXEC:NST:TX:RUN	added	EXEC:NST:TX:STOP	added	CONF:NST:TX:REPEAT_NUM	added	READ:NST:TX:REPEAT_NUM?	added	CONF:NST:TX:PAYLOAD	added	READ:NST:TX:PAYLOAD?	added	CONF:NST:TX:IQ_POLARITY	added	READ:NST:TX:IQ_POLARITY?	added	EXEC:NST:RX:RUN	added	EXEC:NST:RX:STOP	added	CONF:NST:RX:MODE	added	READ:NST:RX:MODE?	added	CONF:NST:RX:BW	added	READ:NST:RX:BW?	added	CONF:NST:RX:SF	added	READ:NST:RX:SF?	added	CONF:NST:RX:IQ_POLARITY	added	READ:NST:RX:IQ_POLARITY?	added	All remote commands as to transmission of MAC commands were moved/renamed from PROTOCOL to LINK	
READ:SENSITIVITY:PACKET_NUM?	renamed from READ:SENSITIVITY:REPEAT?																																																					
CONF:SENSITIVITY:RX_WINDOW	added																																																					
READ:SENSITIVITY:RX_WINDOW?	added																																																					
CONF:SENSITIVITY:DR	added																																																					
READ:SENSITIVITY:DR?	added																																																					
CONF:SENSITIVITY:SET_DR_AT_START	added																																																					
READ:SENSITIVITY:SET_DR_AT_START?	added																																																					
EXEC:NST:TX:RUN	added																																																					
EXEC:NST:TX:STOP	added																																																					
CONF:NST:TX:REPEAT_NUM	added																																																					
READ:NST:TX:REPEAT_NUM?	added																																																					
CONF:NST:TX:PAYLOAD	added																																																					
READ:NST:TX:PAYLOAD?	added																																																					
CONF:NST:TX:IQ_POLARITY	added																																																					
READ:NST:TX:IQ_POLARITY?	added																																																					
EXEC:NST:RX:RUN	added																																																					
EXEC:NST:RX:STOP	added																																																					
CONF:NST:RX:MODE	added																																																					
READ:NST:RX:MODE?	added																																																					
CONF:NST:RX:BW	added																																																					
READ:NST:RX:BW?	added																																																					
CONF:NST:RX:SF	added																																																					
READ:NST:RX:SF?	added																																																					
CONF:NST:RX:IQ_POLARITY	added																																																					
READ:NST:RX:IQ_POLARITY?	added																																																					
All remote commands as to transmission of MAC commands were moved/renamed from PROTOCOL to LINK																																																						
V1.0	2017.06.05	Firmware version: V1.01 - First released																																																				